

# HYGIENIC VALVE PROGRAM

TECHNICS IN STAINLESS STEEL FOR FOOD,  
CHEMICAL AND PHARMACEUTICAL INDUSTRIES





  
**RIEGER**  
www.rieger.de  
Made in Germany

**CERTIFIED**  
ENGINEERING &  
**EHEDG**  
HYGIENIC & DESIGN GROUP  
EUROPEAN GROUP  
**TYPE EL**

## Our ideas – your advantages

- valve body from **solid bar** – many mounting positions possible depending on draining
- optimum cleanability
- interior surface  $Ra \leq 0,8 \mu m$  (32) (standard)
- optional interior surfaces available upon request
- no sump or dome in product space
- **no dead space**
- valves available meeting **3-A standards and EHEDG guidelines**
- **gentle** product handling
- easy maintenance without special tools
- minimal downtime
- tube outlets available as DIN, OD tube and ISO
- seals conform with FDA, 3-A
- thanks to the **building block system** change to aseptic type is simple
- **long stroke and full stroke valves** are available
- The **pneumatic actuator** can be ordered as „air to open/spring to close“, „spring to open/air to close“ or „air/air“.
- **A 3-position actuator** permits simple static dosing processes.
- proximity switches and control tops optional



# Hygienic and aseptic valves



## The building block system

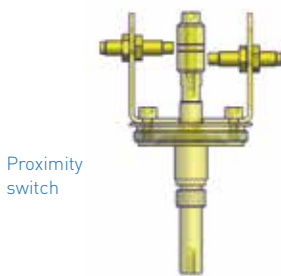

Proximity switch

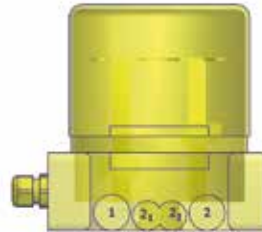

Control top



Pneumatic actuators



Aseptic spindles - PTFE bellows



Body combinations

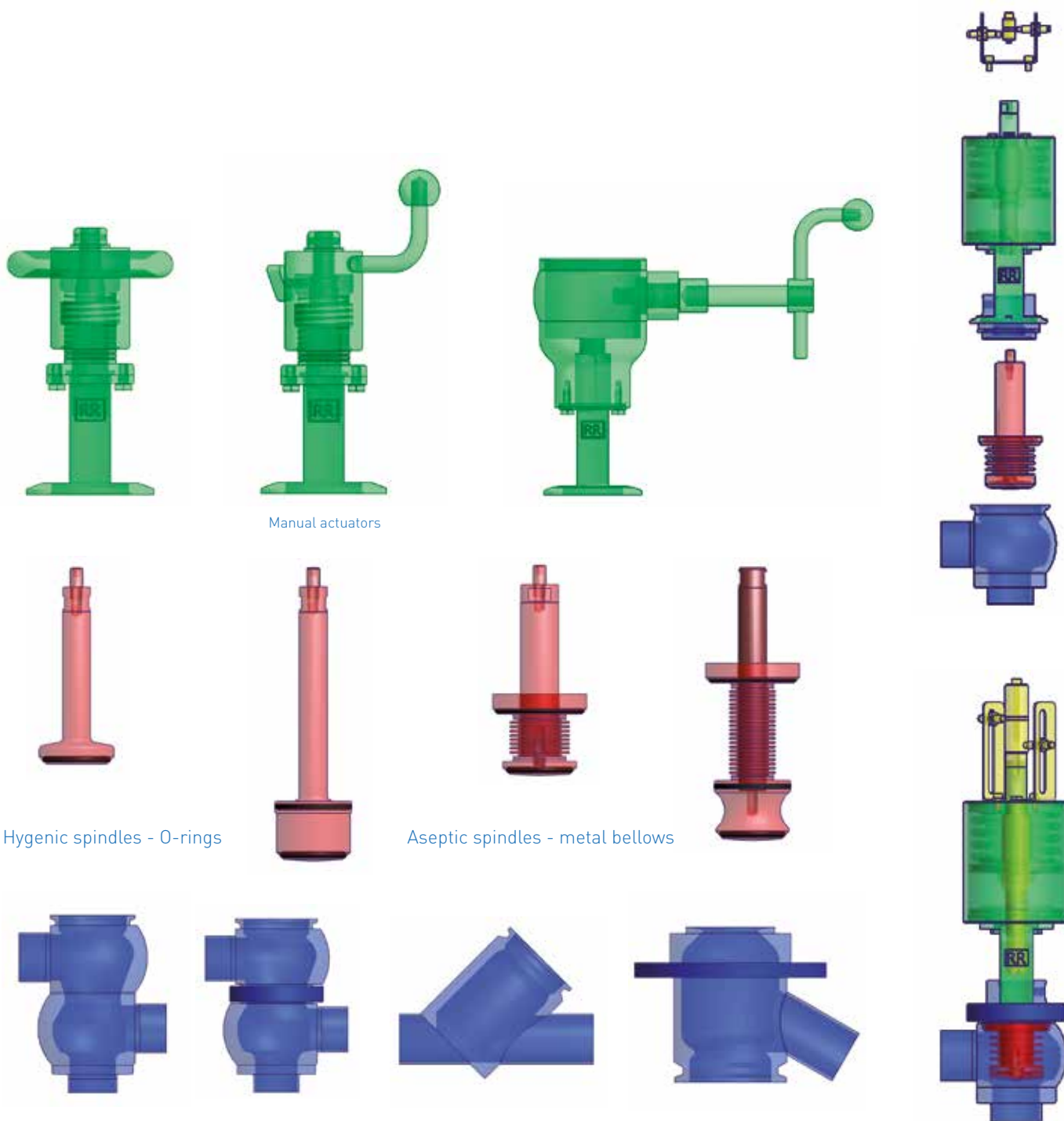

Manual actuators

Hygienic spindles - O-rings

Aseptic spindles - metal bellows

# Single seat valves



...for all range of application



Right angle valve



Right angle valve with manual handle



Inclined-seat valve



Change-over valve  
two-part valve body  
alternatively one-part valve body



Bottom seat valve



Double seal valve DD



Piggable double seal valve N4



Overflow valve ÜS  
optional manual operation



Overflow valve E8  
with T-body



Safety valve SH  
TÜV approved



# Hygienic overflow valve ÜS



... protect your process and equipment



Rieger overflow valves type ÜS open when the set pressure is reached to prevent excess pressure in piping or systems.

These are not safety valves. If safety valves are required, we recommend our TÜV approved safety valves type SH (see page 8).

## Data

- valve body from solid bar
- standard with weld ends – other optional connections available
- optional with lever for lifting in type ÜS or pneumatically lifted in type E8 (see page 7)



# Hygienic overflow valve E8



## ... for a safe pressure reduction

The Rieger overflow right angle valve E8 is a combination of right angle and overflow design. The desired pressure is adjustable, with a valve stroke as high as possible.

Unlike an overflow valve this valve can be opened up to 100% – like an angle valve.

Will protect positive pumps.

A body clamp union between valve body and actuator, starting from size DN 25 (1") can be removed with simple hand tools.

The overflow valve type E8 is suitable for liquid media. It is not a safety valve. For this purpose, we recommend our TÜV approved safety valve type SH (see page 8).

### Data

- standard pressure range 0,5 to 6 bar
- optional: higher set pressures upon request
- protects pumps, pipelines and equipment



# Hygienic safety valve SH



... with TÜV-approval for gas and steam



The Rieger safety valve Type SH prevents excess pressure of gaseous media in pipelines and vessels.

The set pressure is always higher than the operating pressure. As soon as the pressure is reached, the valve opens against the force of the spring. The pressure excess is relieved as soon as the pressure is 10% higher than the set pressure.

## Data

- valve body from solid bar
- no dead spaces
- easy maintenance without special tools
- range of setting – see catalogue
- additionally liftable – pneumatic and/or with lever during cleaning

# Hygienic regulating valve E



... providing product control at desired flows

Rieger regulating (control) valves are designed to meet the highest process demands of hygiene and safety.

Ideal applications include the dairy, beverage, brewery, food, pharmaceutical, biotechnology and personal care industries.

Thanks to the building block system the change between aseptic and hygienic design – and between manual or pneumatic actuator is possible.

Regulating valves are engineered to meet customer's specific processes requirements.





... a safe media separation



Rieger double seal valves are used for reliable separation of product from cleaning agent. The leakage space is situated between the separating gaskets. The leakage fluid flows through two leakage valves.

## Data

- valve body from solid bar
- no dead spaces
- safe CIP/SIP-cleaning
- inexpensive alternative to mix proof valves e. g. in CIP-clusters
- used in beverage and food plants

## ... piggable

The RIEGER double seal valve **piggable version N4** allows potential savings for products, water and cleaning chemicals in combination with a pigging station.

Reduced environmental pollution plus additional product savings shorten the Return On Investment (ROI) and amortization period.

### Daten

- valve body from solid bar
- no torsion when welded
- only 4 seals in product space
- safe CIP/SIP cleaning
- maximum product recovery
- minimal CIP water consumption
- minimal CIP chemical consumption
- lowers waste water costs
- registered design



Two-way connection between main and CIP valve

also available as 3-A version



# Hygienic mix proof valve N1



...reliable separation of liquids



also available as  
3-A version  
N2 PMO 3-A



## Valve structure

- valve body from solid bar
- radial sealing of both valve seats
- balanced valve disks

## Easy of servicing

- only 4 seals in product space
- change of seals without special tools
- service possible without compressed air
- minimal downtime
- light: valve DN 100 (4") only weighs 35 kg (77 lbs)

## Product protection

- stroking without product loss
- safe media separation of both product lines
- closing force up to 10 bar (145 psi)
- water-hammer safe up to 30 bar (435 psi)
- CIP-cleaning and SIP-sterilization automation
- For CIP-cleaning both seats are lifted in turns.
- 3-A and EHEDG certified

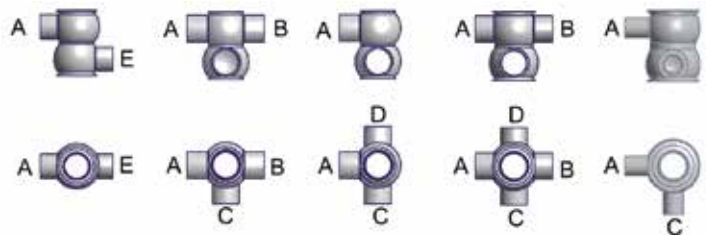



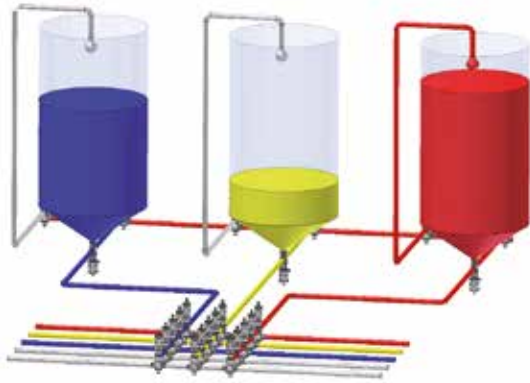

valve matrix

large



small

Typ 150

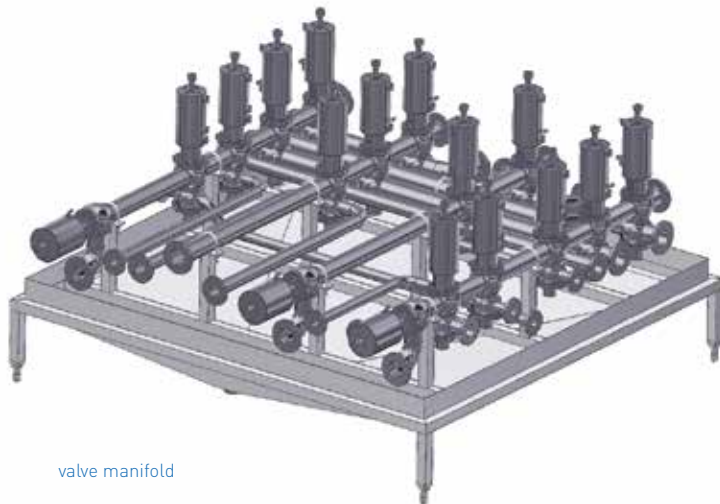

valve manifold



small

large

Typ 200

## Operating mode

L3 – compressed air connection for stroking the upper valve disk

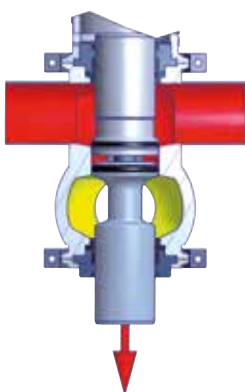

L2 – compressed air connection for stroking the lower valve disk

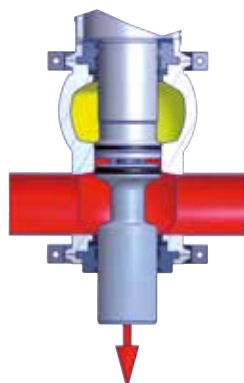

Valve closed

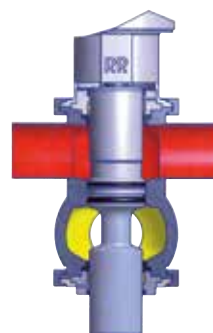

L1 – compressed air connection for opening the valve

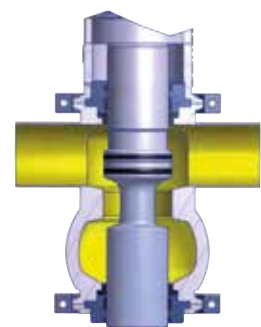



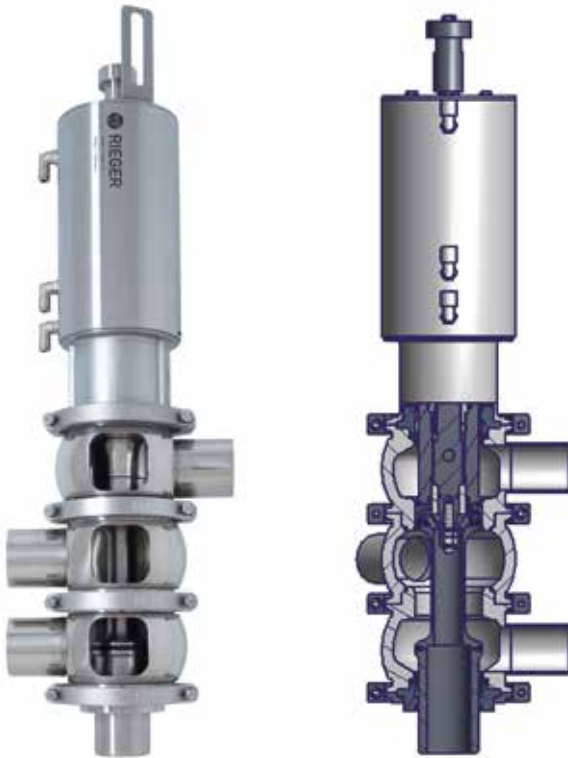

## Valve structure

- based on the N1 technology with additional change-over function
- two-part valve body – lower body turnable
- optional three-part valve body – all bodies turnable
- upper valve seat can be stroked upwards and downwards

# Hygienic mix proof bottom seat valve N5



## Valve structure

- with weld-in flange
- optional vessel connections available
- can be stroked on both sides
- available with only one outlet
- for product pressure in the tank up to 4 bar (58psi)

# Hygienic mix proof bottom seat change-over N9



Rieger offers mix proof bottom seat valves where additionally the function of a change-over valve is utilized.

The advantage is the pipeline is not filled during filling or emptying of multiple vessels. The pipeline is only open while the vessel is filled. This avoids an additional risk of contamination caused by otherwise necessary shut-off valves.

## Valve structure

- valve body from solid bar
- for product pressure in the tank up to 4 bar (58psi)
- also available with separate weld-in flange



pipe connection



weld-in flange

## Operating mode

position "vessel closed"  
passage open

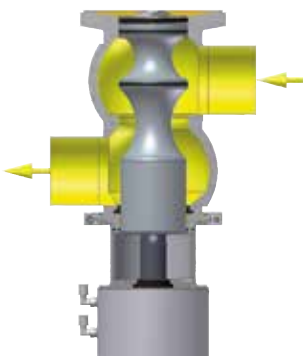

position "vessel open"  
passage closed

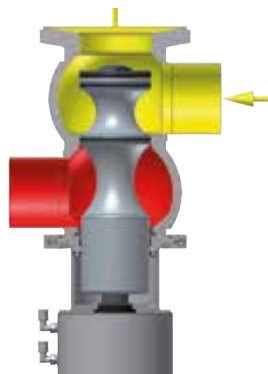

cleaning of piping and  
valve seat

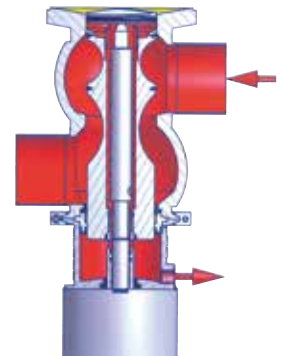



|                              |                             |   |  |
|------------------------------|-----------------------------|---|--|
| <b>Material</b>              | in contact with product     | 1.4404/AISI 316L  |  |
|                              | optional                    | 1.4435/AISI 316L (others on request)                                  |  |
|                              | not in contact with product | 1.4301/AISI 304   |  |
| <b>Product contact seals</b> |                             | EPDM (FDA)  | PTFE (FDA)   |
|                              |                             |   |  |
| <b>Temperatures</b>          | for continuous operation    | 130 °C (EPDM)*<br>266 °F  | 121 °C<br>250 °F   |
|                              | for sterilization           | 150 °C (EPDM)*<br>302 °F  | 135 °C<br>(for a short time)<br>275 °F<br>(for a short time) |
| <b>Pressure</b>              | operating pressure          | max. 6 bar (standard) - higher upon request<br>max. 87 psi (standard) |  |
|                              | controlled pressure         | min. 6 bar – max. 10 bar<br>min. 87 psi – max. 145 psi                |  |
| <b>Surfaces</b>              | in contact with product     | Ra ≤ 0,8 µm (32)  |  |
|                              | not in contact with product | rotated, Ra ≤ 1,6 µm (63)   |  |
|                              | optional                    | higher quality surfaces on demand<br>e.g. electro polished            |  |
| <b>Connections</b>           | standard                    | weld end  |  |
|                              | optional                    | all common threads and<br>flange connections                          |  |

\* depending on operating parameters



## ... industries of application

|  |                               |                         |
|--|-------------------------------|-------------------------|
| <b>Pharmaceutic<br/>Biotechnology<br/>Cosmetics<br/>Chemical</b> | B. Braun Melsungen            | Kwizda Pharma           |
|  | Bayer Schering Pharma         | Merck                   |
|  | Dr. Hobein (Eubos)            | Novartis                |
|  | Ecolab                        | Queisser Pharma         |
|  | Fresenius Medical Care        | Rentschler              |
|  | HAKA Kunz                     | Sandoz                  |
|  | Inova pharma systems          | Sanofi-Aventis          |
|  | kocher-plastik                | Sartorius               |
| <b>Dairies</b>   | Bayernland                    | Hochwald                |
|  | Bergland Naturkäse            | Kärtnermilch            |
|  | Breisgaumilch                 | Meggle                  |
|  | FrieslandCampina              | MZG Molkerei Zeulenroda |
|  | Danone                        | Starmilch               |
|  | DMK                           | Tirol Milch             |
|  | Ehrmann                       | Zott                    |
| <b>Beverages</b>   | Altmühltaler Mineralbrunnen   | Mineralbrunnen AG       |
|  | Brandenburger Urstromquelle   | Ricker Fruchtsäfte      |
|  | Brasseries Kronenbourg        | Sinziger Mineralbrunnen |
|  | EICO-Quelle                   | Thüringer Waldquell     |
|  | Glashäger Brunnen             | WEG Weser-EMS           |
|  | Markengetränke Schwollen      | Ybbstaler Fruchtsaft    |
| <b>Plant engineering</b>   | ALPMA Alpenland Maschinenbau  | Krones                  |
|  | AT Anlagentechnik             | LTH Dresden             |
|  | Belimed                       | MHG Anlagenbau          |
|  | BIS Industrietechnik Salzburg | Miteco AG               |
|  | Döhler Engineering            | Oystar-Gruppe           |
|  | Elopak                        | Pharmaplan              |
|  | Höfliger                      | Ruland                  |
|  | HOSOKAWA ALPINE               | Sepelec                 |
|  | Idoneus                       | SIG Combibloc Systems   |
|  | KHS                           | Täschner Engineering    |
|  | Kinetics                      | Tetra Pak               |

Further references upon request. Please use our contact form on our website [www.rr-rieger.de](http://www.rr-rieger.de)

# Aseptic valves in operation



... in dairies, for food and beverages



New production techniques and a high safety of process equipment are the challenges of the future. RIEGER valves make a contribution to achieve a maximum of productivity, safety and quality in dairies, food and beverage industry.

Strictly made of solid bar, the valve bodies even comply with very high requirements in terms of puncture resistance, absence of distortions and stability. Precisely tailored, either as single valve or combined to valve blocks, they accurately fit in installations while being exchangeable among each other.

The building block system allows unproblematic change between manual and pneumatic actuation as well as between hygienic and aseptic realisation. Equally, a modification of the sealing system is simple – from “spring close / air open” to “spring open / air close” and vice versa.

Thus, RIEGER valves are easily adaptable to changing process requirements.

We adapt our valves to your process. So you don't have to adapt your process.



**The RIEGER valve range stands for reliability**





## ... in pharmaceutical, chemical and bio-engineering industries

Aseptic production equipment in the area of the pharmaceutical and biotechnological industry set new benchmarks for aseptic components such as valves. These are only met with a consequent selection of materials and an uncompromisingly aseptic realisation.

Integrated into pharmaceutical installations for absolutely clean applications, RIEGER valves successfully demonstrate their excellent aseptic properties since years by hermetically separating products from the environment.

RIEGER valves can be found all over the world. Whether Europe, Asia, Africa, Oceania or America – they call every continent and every climate zone their home.

As a renowned German company and part of the worldwide operating NEUMO Ehrenberg Group, RIEGER disposes of the necessary economic capacity and international experience to supply all markets.

Whether bottom seat valves for fermenters, inclined seat valves with bottling functions or sampling valves, the emphasis of construction is always laid on the proper aseptic operation of the valve.



### in process control and installations







The company Rieger is a company with long tradition.

It was founded 1879 as machine

factory in the center of Aalen.

Being subdivided into the two departments machine factory and aluminium foundry, today, RIEGER is member of the worldwide operating NEUMO Ehrenberg Group.

RIEGER machine factory successfully competes in the areas of armatures, valves and welded constructions. All products are basically made of stainless steel, offering the full range of stainless steel types from AISI 304 via 316 L up to hastelloy steel and special materials.

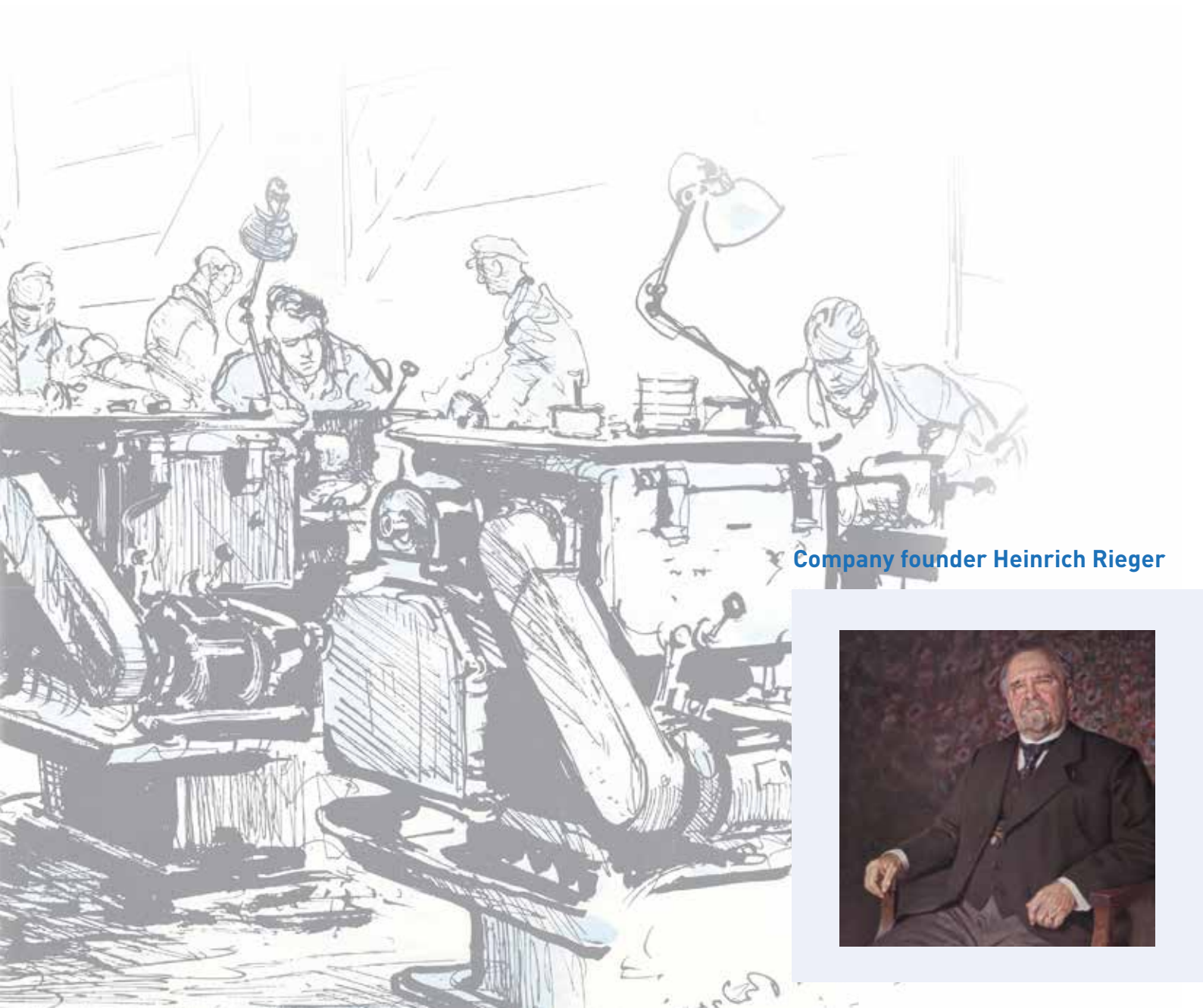

Company founder Heinrich Rieger

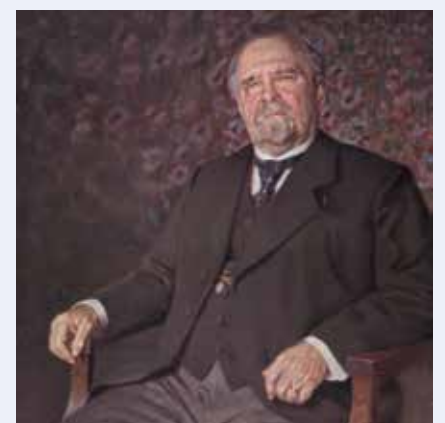







- 2015**

Foundation of RIEGER USA

- 2012**

Aseptic Pigging System

- 2005**

DIN ISO 9001 Certification

- 2004**

First 5 - Axis Machining Center

- 2002**

3-A Approval for the US Market

- 2001**

FEM Calculations

- 2000**

Aseptic Valve Technology

- 1999**

Double Seat Mix Proof Valves

- 1991**

Moving into the industrial area

- 1958**

Member of NEUMO Ehrenberg Group



- 1879**

Foundation



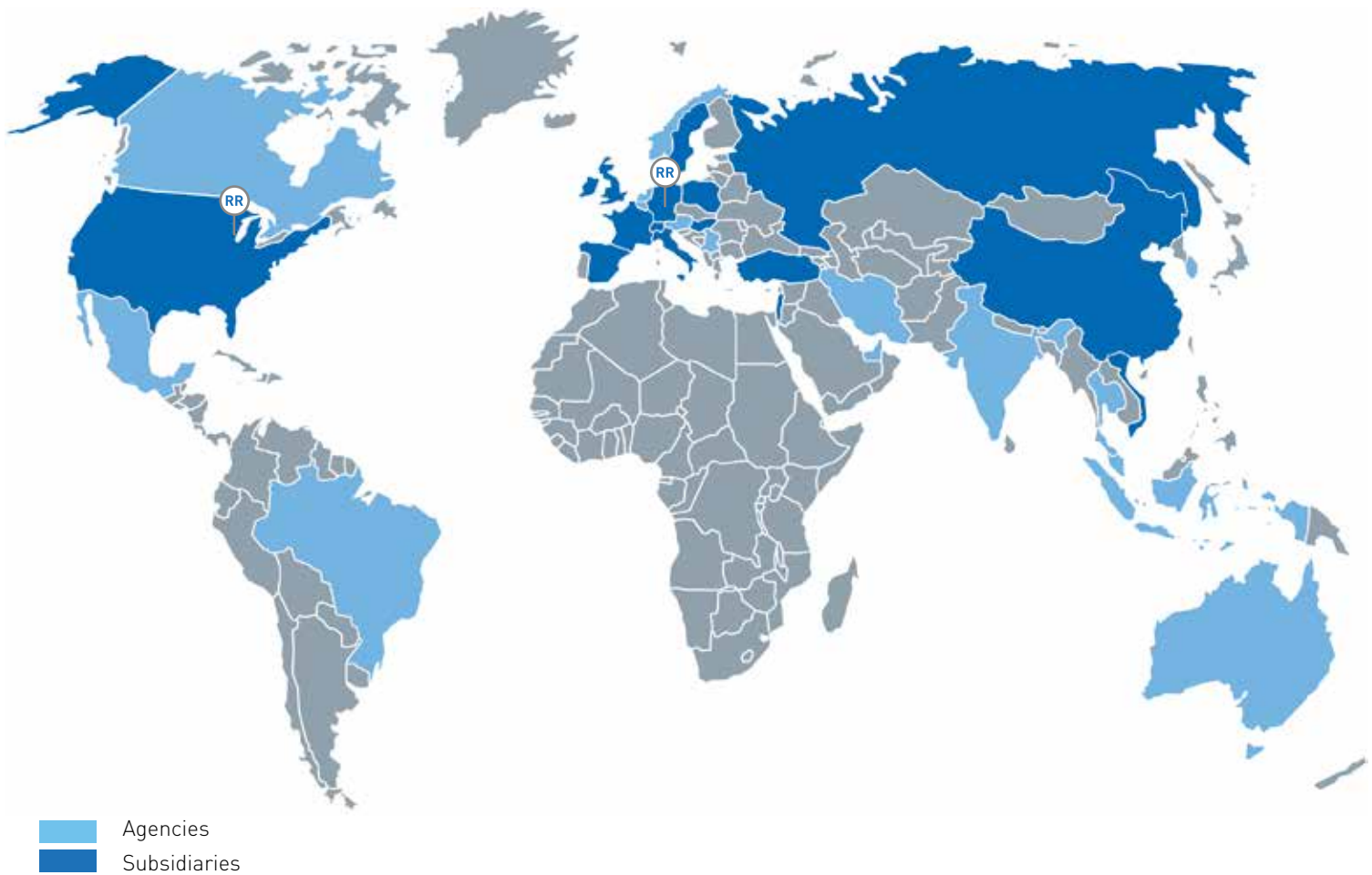

# RIEGER worldwide



The **NEUMO Ehrenberg Group** is an owner-managed, globally operational group of companies with more than 1,800 staff.

Gebr. Rieger has been a member of the globally operational **NEUMO Ehrenberg Group** since 1958. At its machinery factory Gebr. Rieger produces its highly successful **hygienic** and **aseptic valves** and welded constructions.

Due to this global orientation, Rieger was able to achieve international recognition within the food and beverage and pharmaceutical markets within a very short space of time.

Besides **sampling valves**, our main products also include **double-seated valves**, **filler valves** and **pig trap stations**.

## Gebr. Rieger GmbH + Co. KG

Kochertalstraße 32  
DE-73431 Aalen  
Phone: +49 7361 - 57 02-0  
Fax: +49 7361 - 57 02-51  
E-Mail: [info@rr-rieger.de](mailto:info@rr-rieger.de)  
[www.rr-rieger.de](http://www.rr-rieger.de)

