

# Not Binding Operating and Assembly Instruction Progressive Cavity Pump

This operating and assembly instruction is only  
for general information.

Type  
BV €í ĚĠ Áp q ÁĚĚ Š



<b>1</b>	<b>Safety.....</b>	<b>1</b>
1.1	General notes	
1.2	Safety and warning notes	
1.2.1	Warning notes	
1.2.2	Danger symbols	
1.2.3	Information symbols	
1.3	Dangers that can be caused by the machine	
1.4	Qualification of the personnel	
1.5	Authorised people	
1.5.1	Tasks and information for the owner/operators	
1.5.2	Safety notes for maintenance, inspection and assembly work	
1.6	Personal protective equipment	
1.7	Safety and protective devices	
1.8	Foreseeable misuse	
1.9	Designated use	
1.10	Warranty	
1.11	Safety clearance .....	5
1.11.1	General information	
1.11.2	Safety clearance application area	
1.11.3	Definition	
1.11.4	Values for safety clearance	
1.11.5	Reaching across protective constructions	
1.11.6	Reaching around / through openings	
1.12	Separating protective device	
1.12.1	Pump with hopper extension (AST), technical service shutter (KIS) and safety switch	
1.12.2	Pumps with cleanout	
1.12.3	Pump with lid	
1.13	Filling level hopper	
<b>2</b>	<b>Description of the pump.....</b>	<b>9</b>
2.1	General description	
2.2	Mode of action and pumping principle of the pump	
2.3	Constructive design	
<b>3</b>	<b>Technical Data.....</b>	<b>10</b>

<b>4</b>	<b>Transport, Intermediate storage, Disposal.....</b>	<b>12</b>
4.1	Safety	
4.2	Transport	
4.2.1	Dimensions, weight and centre of gravity	
4.2.2	Symbol	
4.2.3	Lashing points (AP) for lifting devices	
4.2.4	Unpacking the machine	
4.3	Temporary storage/corrosion protection	
4.4	Disposal	
<b>5</b>	<b>Assembly / Installation.....</b>	<b>15</b>
5.1	Mounting tools / lifting gear	
5.2	Space requirement	
5.2.1	Dimension for stator replacement	
5.3	Assembly of the complete mounted pump	
5.4	Power supply of the pump	
5.5	Pipelines	
5.5.1	Suction and pressure connection	
5.5.2	Pipeline dimensions	
5.5.3	Residue-free pipelines	
5.5.4	Tension-free assembly	
<b>6</b>	<b>Commissioning / De-Commissioning.....</b>	<b>17</b>
6.1	Commissioning report.....	17
6.2	Measures before commissioning.....	18
6.2.1	Checking pipelines	
6.2.2	Protective devices on the pump	
6.2.3	Electrical / hydraulic connections	
6.2.4	Direction of rotation check	
6.2.5	Additional devices - optional	
6.3	Initial commissioning/repeated commissioning	
6.3.1	Avoiding dry running of the pump	
6.3.2	Pressure in the suction and pressure connection	
6.4	De-commissioning	
6.4.1	Switching off the pump	
6.4.2	Emptying the pump	
6.4.3	Dismantling the pump	
6.4.4	Preservation/storage of the pump	

<b>7</b>	<b>Maintenance</b> .....	<b>23</b>
	7.1 Preventative measures	
	7.1.1 Pump down-time	
	7.2 Lubrication	
	7.2.1 Joint grease	
	7.3 Inspection	
<b>8</b>	<b>Malfunctions, causes, rectification</b> .....	<b>25</b>
<b>9</b>	<b>Pump Dismantling / Reassembly</b> .....	<b>27</b>
	9.1 Pump Dismantling / Reassembly.....	27
	9.1.1 Prepare the pump for dismantling	
	9.1.2 Dismantling	
	9.1.3 Reassembly	
	9.2 Rotating unit – individual parts .....	33
	9.2.1 Dismantling	
	9.2.2 Rotating unit (RTE) - prepare individual parts for reassembly	
	9.2.3 Rotating unit (RTE) - individual parts - reassembly	
	9.3 Holding band - assembly.....	38
	9.3.1 Prepare the holding band	
	9.3.2 Check the holding band	
	9.3.3 Assembling the holding band	
	9.3.4 Correct tension for the holding band (HBD)	
	9.3.5 Cant up the holding band	
	9.3.6 Shear the holding band	
	9.3.7 Check the holding band after assembly	
	9.4 Shaft seal.....	41
	9.4.1 Safety	
	9.4.2 Application conditions and material version	
<b>10</b>	<b>Spare parts</b> .....	<b>4H</b>
	10.1 Order template for spare parts.....	4Í
<b>11</b>	<b>Special tools</b> .....	<b>47</b>
<b>12</b>	<b>Related documents</b> .....	<del>47</del> J
<b>13</b>	<b>Appendix</b> .....	<del>47</del>
	13.1 Manufacturer's documents / suppliers	

**Subsidiaries**



## 1.1 General notes

- Always keep the operating and maintenance instructions close by the machine.
- If problems cannot be solved with reference to the operating and maintenance instructions, please contact the manufacturer.

Observe the following points in addition to these operating and maintenance instructions:



- Prohibition, warning and mandatory signs, warning notes on the machine
- Relevant laws and ordinances
- Statutory provisions on accident prevention
- Corresponding harmonised standards and regulations

## 1.2 Safety and warning notes

- Comply with safety and warning notes for safe and efficient use of the product.

Signal words for specific dangers and (possible) consequences are explained below. These are supplemented by symbols (pictograms) if necessary.

### 1.2.1 Warning notes

<b>NOTICE</b>
<p><b>Caution for machine!</b> Possible danger. Material damage can occur.</p>
 <b>CAUTION</b>
<p><b>Caution for people and machine!</b> Possible danger. Minor injury or damage to property can occur.</p>
 <b>WARNING</b>
<p><b>Warning for people!</b> Possible danger. Death or serious injury can occur.</p>
 <b>DANGER</b>
<p><b>Danger for people!</b> Possible danger. Immediate risk of sever or fatal injury.</p>

### 1.2.2 Danger symbols



Warning:  
Suspended load.



Warning:  
Dangerous electrical  
voltage.

### 1.2.3 Information symbols



Ensure environmental protection.      Wear eye protection.

- Instruction to act/take measures
- List item

### 1.3 Dangers that can be caused by the machine

seepex machines are built in accordance with the state of the art.

Nevertheless, there is a residual risk, because the machine works with:

- Mechanical movements that pose a danger
- Electrical voltages and currents

We have used design measures and applied safety technology to minimise the risk to the health of people posed by this danger.

### 1.4 Qualification of the personnel

This handbook is intended for:

- Owner
- Operators
- Setters
- Maintenance personnel

### 1.5 Authorised people

People authorised to undertake operation, set up and maintenance are instructed and trained specialists employed by the owner/manufactururer.

Detailed technical knowledge is essential for performing any work on the machine.



The owner is responsible for:

- Personnel training
- Compliance with safety regulations
- Compliance with operating and maintenance instructions

The operator must:

- Have received instruction
- Read and understood the relevant parts of the operating instructions before starting work
- Know the safety devices and regulations



**1.5.1 Tasks and information for the owner/operators**

- Regularly check and maintain the machine, replacing all parts in good time which no longer guarantee safe operation.
- It is essential to comply with the procedure described in the operating instructions for shutting down the machine.
- On completion of work, attach all safety and protective devices and make sure they are functioning.

**1.5.2 Safety notes for maintenance, inspection and assembly work**

- Do not work on the machine or system unless it is stationary and depressurised.
- Switch off the master switch and pull out the power plug before starting work on live components.
- Comply with the procedure for shutting down the machine as described in the Shut-down chapter.
- Decontaminate (de-toxify) machines that are used for pumping media that can be harmful to health.
- Refer to the Initial start-up chapter before repeated start-up of the machine.

**1.6 Personal protective equipment**

- Wear personal protective equipment and/or additional equipment for your own safety.
- Avoid/limit risks by the use of collective technical protective equipment or by organisational measures at work.

**1.7 Safety and protective devices**

- Prior to start-up, bolt seepex machines onto a concrete foundation so as to ensure stability.
- Starting and stopping devices must be clearly recognisable. Take appropriate measures to avoid defects.
- No protective device is necessary for checking and/or setting the shaft seal.
- Hot surfaces are identified with a danger symbol on the machine.

**1.8 Foreseeable misuse**

Serious personal injury and damage to property can be caused by:

- Incorrect use
- Incorrect installation or operation of the machine
- Impermissible removal of necessary protective equipment

## 1.9 Designated use

- Only use seepex machines if they are in perfect condition and in compliance with the operating and maintenance instructions.
- Do not start up the machine unless the system in which the machine is installed is in accordance with the provisions of the applicable guidelines and statutory regulations.
- Equivalent sustained sound pressure level at workplaces of operating personnel C75 dB (A). Cavitation-free operation of the machine and screwed connection to concrete foundation are essential.
- seepex machines are components that are exclusively intended for pumping media in accordance with the technical data (→ chapter 3). Written approval must be obtained from the manufacturer before other media are pumped.
- Refer to the information on the type plate and the operating instructions for technical data (→ chapter 3), and comply with them.
- The operating instructions are assigned to the seepex machine based on the commission number.

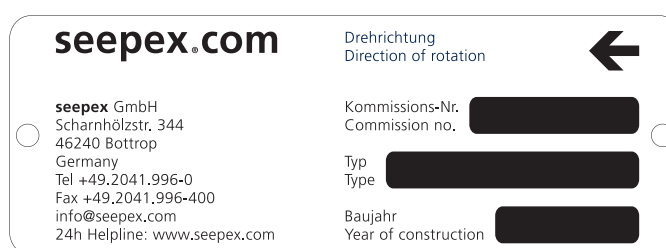

Fig. 1-1 Similar illustration

## 1.10 Warranty

- Warranty in accordance with our terms and conditions of delivery and order confirmation.
- It is a condition of the machine warranty that the machine must correspond to the listed operating instructions in accordance with the type plate/data sheet.
- All wearing parts are excluded from the warranty.
- These operating instructions are subject to copyright. Reproduction is not permitted and will be punished. Contravention will be pursued through the courts.

## 1.11 Safety clearances

### 1.11.1 General

- Open hopper pumps are not ready-to-run units in delivery condition, therefore they are supplied with a declaration by the manufacturer.
- The owner is responsible for appropriate protective devices/feeder hoppers in order to guarantee conformity of the system.

### 1.11.2 Applicability of the safety clearances

- Inadequate protection for certain dangers (e.g. radiation and substance emissions).
  - Additional or other measures necessary.
- Protection for those persons who are attempting to reach danger areas without additional help and under the conditions defined for various situations of reaching up, reaching under or reaching through.

### 1.11.3 Definition

#### 1.11.3.1 Protective structure

- Use a physical barrier (e.g. guard, part of a machine) in order to limit movement of the body or a body part.

#### 1.11.3.2 Safety clearance

- Use appropriate minimum clearance by means of protective structure in front of the danger area.

### 1.11.4 Values for safety clearances

#### 1.11.4.1 Precondition

Safety clearances defined as follows:

- Protective structures and openings in them retain their shape and position.
- Measure safety clearances between limiting surfaces and the body or affected body part.
- Danger area can be reached with difficulty.
- The reference level is the level on which people normally stand, e.g. floor or working platform.
- Do not use any objects such as chairs, ladders to change the reference level.
- Do not use any objects such as rods or tools to extend the natural reach of upper extremities.

#### 1.11.5 Reaching overprotective structures

The following code letters are used

a = Height of the danger area

b = Height of the protective structure

c = Horizontal distance to the danger area

- If the danger area represents a severe risk, then the values in the table or other technical safety measures must be used.
- If the known values for a, b or c fall between two values in the table, use values that result in a higher level of safety.

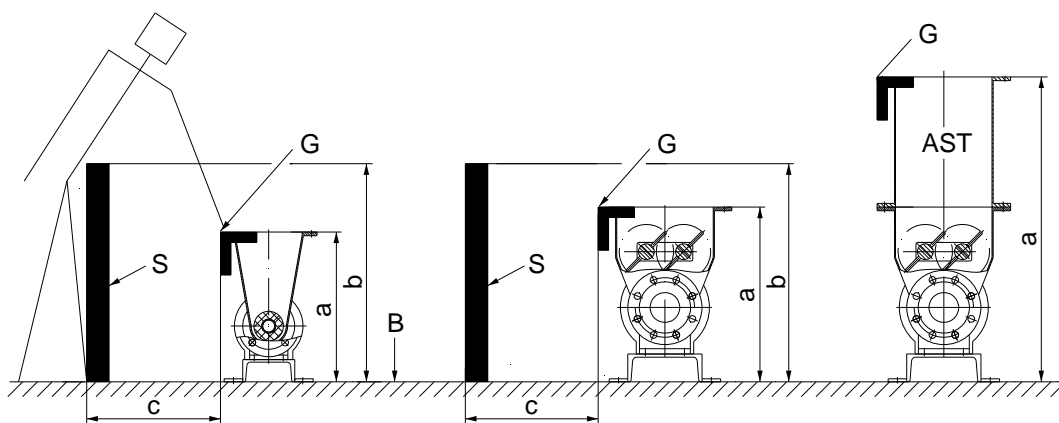

Height of the danger area a	Height of the protective structure b <sup>1)</sup>									
	1000	1200	1400 <sup>3)</sup>	1600	1800	2000	2200	2400	2600	2700
2700 <sup>2)</sup>	-	-	-	-	-	-	-	-	-	-
2600	900	800	700	600	600	500	400	300	100	-
2400	1100	1000	900	800	700	600	400	300	100	-
2200	1300	1200	1000	900	800	600	400	300	-	-
2000	1400	1300	1100	900	800	600	400	-	-	-
1800	1500	1400	1100	900	800	600	-	-	-	-
1600	1500	1400	1100	900	800	500	-	-	-	-
1400	1500	1400	1100	900	800	-	-	-	-	-
1200	1500	1400	1100	900	700	-	-	-	-	-
1000	1500	1400	1000	800	-	-	-	-	-	-
800	1500	1300	900	600	-	-	-	-	-	-
600	1400	1300	800	-	-	-	-	-	-	-
400	1400	1200	400	-	-	-	-	-	-	-
200	1200	900	-	-	-	-	-	-	-	-
0	1100	500	-	-	-	-	-	-	-	-

- 1) Protective structures less than 1000 mm in height are not included, because movement is not satisfactorily restricted.
- 2) If the danger area represents a minor risk, the height h of the danger area must be 2500 mm or more.  
If the danger area represents a high risk, then
- either the height h of the danger area must be 2700 mm or more
  - or other technical safety measures must be used..
- 3) Protective structures below 1400 mm should not be used without additional technical safety measures. (Source: DIN EN ISO 13857)

### 1.11.6 Reaching around/reaching through openings

Danger in the working area of rotating shafts.

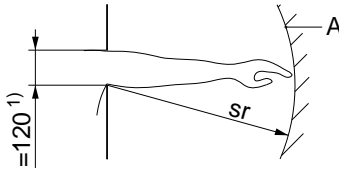
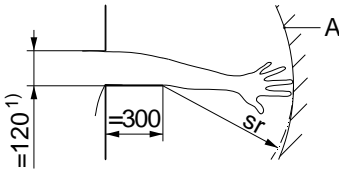
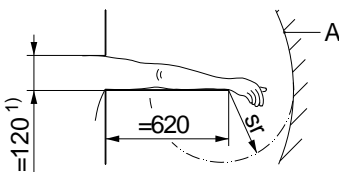
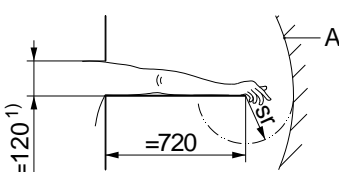
Limitation of movement	Safety clearance $s_r$	Figure
Only at shoulder and armpit	$\geq 850$	
Arm supported up to the elbow	$\geq 550$	
Arm supported up to the wrist	$\geq 230$	
Arm and hand supported up to the finger root	$\geq 130$	

A: Movement area of the arm

1) Either diameter of a round opening, side of a square opening or width of a slot-shaped opening (source: DIN EN ISO 13857)

## 1.12 Guard

### 1.12.1 Pump with feeder hopper (AST), inspection hatch (KIS) with safety switch (SHS)

- Before start-up, integrate the safety switch into the electric control system so that the following components are switched off and prevented from reactivation when inspection hatch (KIS) is opened.
  - Bridge breaker driver
  - Pump drive
  - Other drive units projecting into the interior
- Switch off all media feeds in the feeder hopper immediately.
- Restart the system after closing inspection hatch (KIS).
- Press reset to switch on the components.

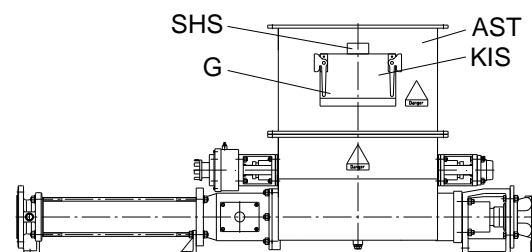

### 1.12.2 Pump with cleaning cover

- Before opening cleaning cover (RGD), switch off the pump drive and bridge breaker drive and prevent them from being switched back on.
- Start up the pump drive and bridge breaker drive after closing cleaning cover (RGD).

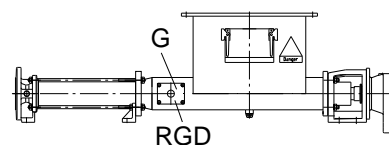

### 1.12.3 Pump with cover

- Open cover (DEK) for topping-up purposes, but first switch off the pump drive and secure it against being switched back on.
  - The owner may install a safety switch which is integrated in the electric control unit.
- Do not switch on the drive until after closing the cover.

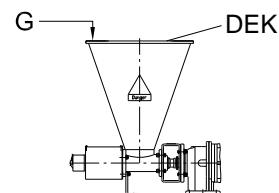

### 1.13 Filling level hopper (500)

- Fill in the hopper (500) max. up to the top edge of the auger feed screw.
- Install alternative a level control (F).

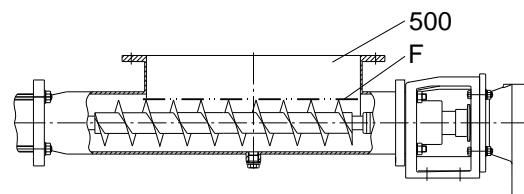

### 2.1 General description

seepex pumps are members of the group of rotating displacement pumps.

- Characteristic features
  - Special configuration/arrangement of the rotor and stator pumping elements.
  - Motion sequence

### 2.2 Mode of action and pumping principle of the seepex pump

- Sealing bands are produced through geometric design/contact of both conveying elements.
- Sealing bands ensure a perfect fit between the suction and pressure side.  
Result:
  - Increased pump suction.
  - Higher pressure build-up independent of speed possible.

### 2.3 Constructive design

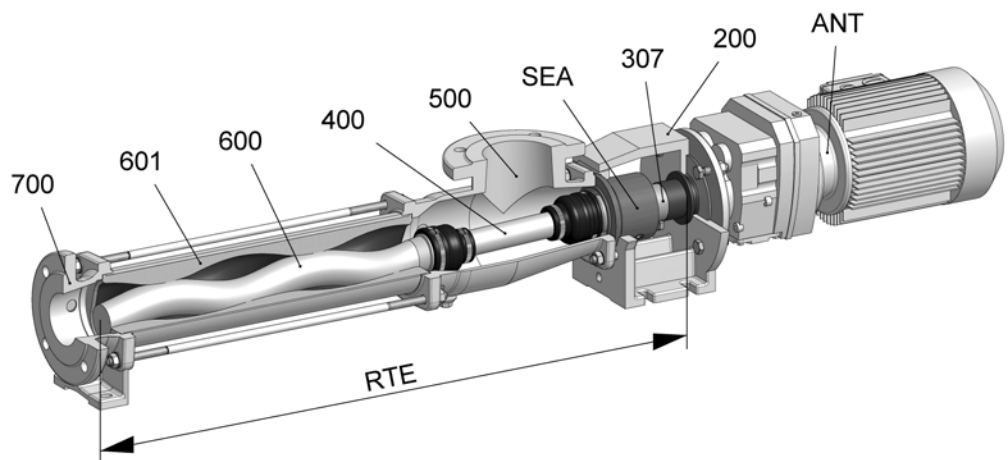

No.	Designation
ANT	Drive
200	Lantern
307	Plug-in shaft
400	Coupling rod
SEA	Shaft seal
500	Suction casing
600	Rotor
RTE	Rotating unit
601	Stator
700	Pressure branch





**3.1 Data sheet**

**3.2 Characteristic Curves**

**3.3 Declaration**

- Data sheet, characteristic curves and declarations are commission specific documents and not part of this not binding operating and assembly instruction.



#### 4.1 Safety

 <b>CAUTION</b>
<p><b>Damage to property/injuries due to incorrect transport</b> Slight injury or damage to property can occur</p> <ul style="list-style-type: none"> <li>➤ Comply with the safety notes and transport notes on the packaging.</li> <li>➤ Use suitable means of transport, lifting devices and tools.</li> <li>➤ Use protective equipment.</li> </ul>

#### 4.2 Transport

##### 4.2.1 Dimensions, weights and center of gravity

- Note the dimensional drawing (→ chapter 5.6).

##### 4.2.2 Symbols

- Meaning of symbol

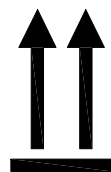

Top



Fragile  
item



Against moisture  
protect

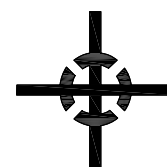

Centre of gravity



Lashing points

##### 4.2.3 Sling points (AP) for lifting devices

	<b>WARNING</b>
<p><b>Warning of suspended load.</b> Death or serious injury can occur.</p> <ul style="list-style-type: none"> <li>➤ Use the lashing points <b>(AP)</b> for lifting devices.</li> <li>➤ Note the centre of gravity (→ dimensional drawing, chapter 5.6).</li> </ul>	

Lifting machine

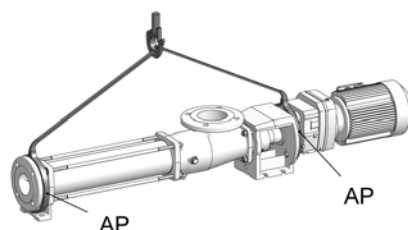

Industrial trucks

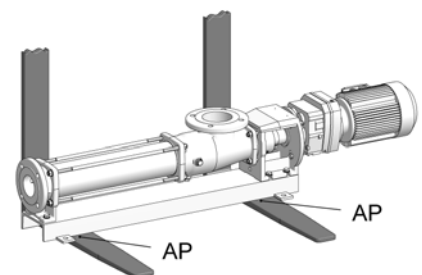

##### 4.2.4 Unpacking the machine

- Comply with the symbols and notices on the packaging.
- Remove the screwed connection between the machine and packaging.
- Remove the machine with a lifting machine/industrial truck.

#### 4.3 Temporary storage/Corrosion protection

- All seepex machines have corrosion protection applied as standard prior to transport.

<i>NOTICE</i>	
	<p><b>Damage to property if corrosion protection is missing</b> Property damage can occur due to corrosion.</p> <ul style="list-style-type: none"><li>➤ Temporary storage must be in a dry, enclosed, frost-free room in order to provide protection against ambient influences.</li><li>➤ Contact seepex regarding the necessary corrosion protection for temporary storage.</li></ul>

#### 4.4 Disposal

	<i>NOTICE</i>
	<p><b>Environmental protection</b> Material damage can occur.</p> <ul style="list-style-type: none"><li>➤ Drain the pumping medium and dispose of it in accordance with the regulations.</li><li>➤ Dispose of the machine with regard to its composition and existing regulations.</li></ul>

## 5.1 Mounting tools / lifting gear

 <b>CAUTION</b>	
<p><b>Pump falling over.</b> Slight injury or damage to property can occur.</p> <ul style="list-style-type: none"> <li>➤ Adhere to the lifting tool's starting point.</li> <li>➤ Pay attention to the dimensions, weight and centre of gravity of the pump.</li> <li>➤ Use suitable mounting tools/lifting gear.</li> </ul>	

## 5.2 Space requirement

The required space should be determined by considering the following factors:

- Dimensions and weight.
- Requisite transport and lifting equipment.
- Pipe routing – dismantling (dimension for stator replacement).

## 5.2.1 Dimension for stator replacement (P)

- Refer to the dimensional drawing.

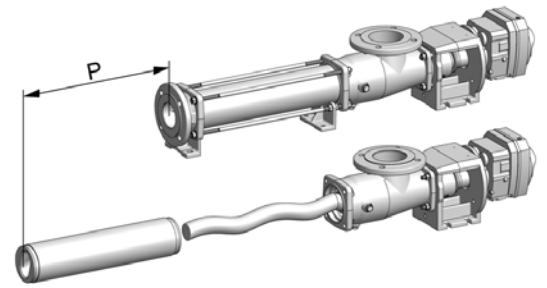

## 5.3 Assembly of the complete mounted pump

- Assemble according to technical data (→ chapter 3.).
- Note dimensional drawing.

**Tension-free mounting of the pump**

- Balance unevenness with suitable supports.
- Applies to mounting on foundations/load-bearing elements.
- Total areas of all pump bearing areas are resting on the surface.

**Correct position of the drives**

- All drives are set up ready for operation and mounted.
- Correct displacements of the drive during transport/installation of the pump by adjusting/fixing the drive.

 <b>CAUTION</b>	
<p><b>Safety protection equipment.</b> Slight injury or damage to property may result.</p> <ul style="list-style-type: none"> <li>➤ Connect safety protection equipment and activate.</li> </ul>	

## 5.4 Power supply of the seepex pump

	<b>! DANGER</b>
	<p><b>Supply voltage and power frequency.</b> Death or serious injury will result.</p> <ul style="list-style-type: none"><li>➤ Heed type plate on the pump.</li><li>➤ Pay attention to manufacturer's directions (→ chapter 13.).</li><li>➤ Pay attention to safety regulations.</li></ul>

## 5.5 Pipelines

### 5.5.1 Suction and pressure connection

- Refer to the dimensional drawing for the position, nominal width and standard.
- Note direction of rotation/flow direction.

### 5.5.2 Pipeline dimensions

- Adhere to specifications regarding pressure in the pressure respectively suction connection.
- Note technical data (→ chapter 3.).
- Nominal width of suction pipe = nominal width of suction connection of pumps.

### 5.5.3 Residue-free pipelines

<b>NOTICE</b>
<p><b>Damage to property through assembly residue.</b> No claims under guarantee if violated.</p> <ul style="list-style-type: none"><li>➤ Keep all pipe work free of foreign objects.</li><li>➤ Remove weld spatters, screws, steel chips etc.</li></ul>

### 5.5.4 Tension-free assembly

- Assemble pipelines and other components in a tension-free manner on the pump.

**Master Copy**

**6.1 Commissioning report**

Send commissioning report online to  
[www.seepex.com](http://www.seepex.com)

**From:**

**Must be specified with every order!**

**Commission:**

**Model:**

\_\_\_\_\_

\_\_\_\_\_

Contact person: .....  
 Tel.: .....  
 Fax: .....  
 E-mail: .....

**Customer Service:**  
 seepex GmbH  
 Postfach 10 15 64  
 D-46215 Bottrop  
 service@seepex.com

<b>Germany</b>
<b>Rest of Europe</b>
<b>Outside Europe</b>

Phone:+49 2041.996-231 Fax: +49 2041.996-431
Phone:+49 2041.996-224 Fax: +49 2041.996-424
Phone:+49 2041.996-120 Fax: +49 2041.996-432

**Address of plant:**

.....  
 .....  
 .....  
 .....

Delivery date:	
Date of installation:	
Assembly check carried out on:	

**Please enter operational data:**

Conveying liquid:	
Temperature:	
Fuse level/motor protection or power consumption	

Frequency control	<input type="checkbox"/> no	
	<input type="checkbox"/> yes	If yes:
		<input type="checkbox"/> Supplied by seepex
		<input type="checkbox"/> Supplied by customer

Frequency:	
Speed:	
Power consumption:	

Place, date

Signature / company stamp





6.2 Measures before commissioning

- Note the technical data (→ chapter 3.).

6.2.1 Checking pipelines

- Check flange screwed connections (**SCH**).

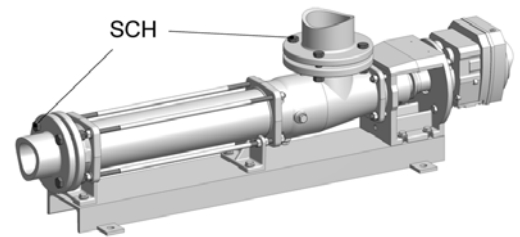

- Check threaded connections (**G**).

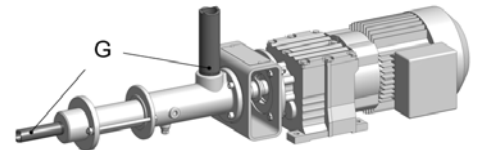

<b>NOTICE</b>
<p><b>Ensure the liquid can flow through without obstruction.</b> Malfunction and/or irreparable damage to the pump.</p> <ul style="list-style-type: none"> <li>➤ Open all shut-off elements before switching on the pump.</li> </ul>

6.2.2 Protective devices on the pump

<b>DANGER</b>
<p><b>Missing protective device.</b> Danger of pulling in and crushing.</p> <ul style="list-style-type: none"> <li>➤ Equip the pump with a protective device. Protective devices provided for preventing contact with surfaces or moving parts must be regarded as suitable if contact is not possible in a test involving a test finger, with regard to the penetration possibility, strength and shock resistance.</li> <li>➤ Comply with national protection regulations.</li> <li>➤ In pumps with an open suction flange/feed hopper, attach touch protection. These safety clearances protect those persons who are attempting to reach danger areas without additional help and under the conditions defined for various situations of reaching up, reaching under or reaching through</li> </ul> <p>In shaft seals, touch protection is only necessary if there are components on the rotating shaft.</p>

6.2.3 Electrical/hydraulic connections

	<b>DANGER</b>
<p><b>Dangerous voltage.</b> Death or serious injury can occur.</p> <ul style="list-style-type: none"> <li>➤ Note safety regulations.</li> <li>➤ Disconnect motor from all sources of energy.</li> <li>➤ Secure electrical connections against restarting.</li> </ul>	

### 6.2.4 Direction of rotation check

- The pump direction of rotation determines the flow direction of the pumping medium.
- Note the direction of rotation arrow on the type plate.

flow direction

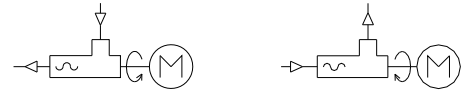

counter clockwise

clockwise

### 6.2.5 Additional devices - optional

- Refer to additional devices (→ chapter 12.1).

### 6.3 Initial commissioning/repeated commissioning

- Start up the pump.

#### NOTICE

##### **Dry running of the pump.**

Malfunction and/or irreparable damage to the pump.

- Fill the suction casing with liquid in order to lubricate the pumping elements.

### 6.3.1 Avoid dry running of the pump

#### NOTICE

##### **High temperature between rotor and stator.**

Stator material burned.

Complete failure of the pump.

- Make sure that the suction-side conveying capacity does not cavitate.
- If this cannot be guaranteed on the machine side, assemble a seepex dry running protection (TSE).

### 6.3.2 Pressure in the suction and pressure connection



#### CAUTION

##### **High pressure.**

Malfunction and/or irreparable damage to the shaft seal or pump.

- Maintain pressure in the suction connection in accordance with the technical data (→ chapter 3.).

#### **Recommendation:**

- Assemble an oil-filled contact pressure gauge to monitor and deactivate the pump.

## 6.4 De-commissioning

Protect the pump and additional devices against the following:

- Frost
- Deposit of solids
- Sedimentation from the liquid
- Corrosion of parts that come into contact with the medium

### 6.4.1 Switching off the pump

	<b>!</b> <b>DANGER</b>
	<b>Dangerous voltage.</b> Death or serious injury can occur. <ul style="list-style-type: none"><li>➤ Note safety regulations.</li><li>➤ Disconnect motor from all sources of energy.</li><li>➤ Secure electrical connections against restarting.</li></ul>

### 6.4.2 Emptying the pump

<b>!</b> <b>CAUTION</b>
<b>Liquid draining out.</b> Minor injury or damage to property can occur. <ul style="list-style-type: none"><li>➤ Wear suitable protective clothing.</li><li>➤ Refer to the technical data (→ chapter 3.) for the corresponding configuration of the pump housing.</li></ul>

To drain the pump:

- If the pump housing has screwed plugs, remove the screwed plugs.
- Drain using a connection branch (suction casing, pressure branch) if the pump housing is coated or the housing does not have screwed plugs.
- Drain the residual liquid from the pump housing.
- Drain the pipelines on the suction and pressure sides, or shut off behind the pump connections.

## 6.4.3 Removing the pump

**WARNING****Risk of pump tipping or falling.**

Death or serious injury can occur.

- Support the drive unit to guarantee stability.

**Pipeline dismantling**

- Remove flange bolts (**SCH**) and flange seals (**DFL**).

with/without base plate

- Remove bolts (**SCH**) from the pump feet.

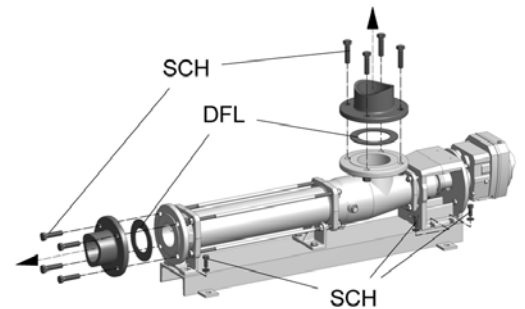
**Pipeline dismantling**

- Remove threaded connections (**G**).

with/without base plate

- Remove bolts (**SCH**) from the pump feet.

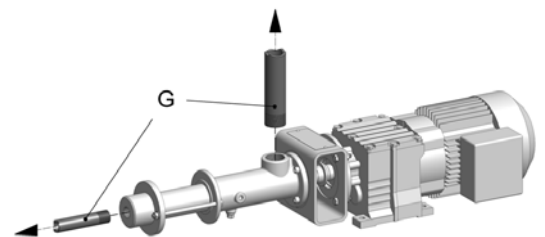

## 6.4.4 Preservation/storage of the pump

**NOTICE****Damage to property due to lack of corrosion protection.**

Property damage can occur due to corrosion.

- Contact seepex to discuss suitable preservation measures.
  - State the commission number of the pump.

7.1 Preventive measures



The maintenance personnel must have these operating instructions, follow them and also require corresponding qualifications.

	<b>! DANGER</b>
	<p><b>Dangerous voltage.</b> Death or serious injury can occur.</p> <ul style="list-style-type: none"> <li>➤ Note safety regulations.</li> <li>➤ Disconnect pump from all sources of energy.</li> <li>➤ Secure electrical connections against restarting.</li> </ul>

7.1.1 Pump down-time

<b>NOTICE</b>
<p><b>Pump down-time.</b> Production failure due to wear.</p> <ul style="list-style-type: none"> <li>➤ Acquisition of a set of wearing parts and a set of gaskets.</li> </ul>

7.2 Lubrication

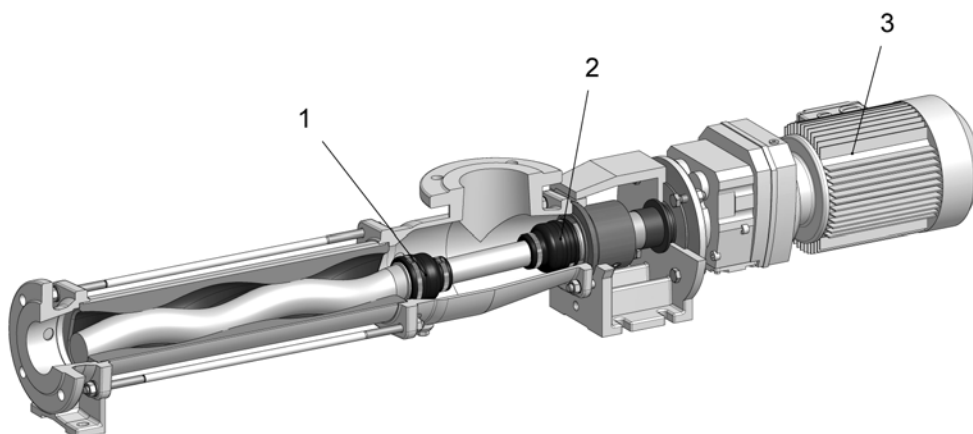

No.	Denomination	Lubricant	Lubricant change in operating hours	Fill volume
1	Pin joint	seepex special grease *	10000 h	*
2	Pin joint	seepex special grease *	10000 h	*
3	Drive	Refer to manufacturer's documentation (chapter 13._)		
	Rotor/stator	Conveying medium	---	---
	Shaft seal	Conveying medium	---	---

\* Type and filling quantities are commission specific information.

## 7.2.1 Joint grease

NOTICE
<p><b>Other grease types.</b> Malfunction and/or irreparable damage to the joints or the pump.</p> <p>➤ Exclusively use seepex special grease.</p>

## 7.3 Inspection

Component	Interval	Action
Joints	Every 10,000 operating hours	Renew joint grease
Stator	Every week	Visual check for leaks
Shaft seal	Every week	Visual check for leaks
Drive unit	Every 3000 operating hours, at least every 6 months	Comply with manufacturer's documentation

Refer to technical data (chapter 3.) for application range of the pump.

Malfunction								Causes	Rectification
Pump is not sucking	Pump pumping unevenly	Conveying capacity is not achieved	Pressure head is not reached	Pump does not start up	Pump seized / pump does not pump	Pump is loud when running	Motor gets too hot		
			X				X	Static friction between stator/rotor too great.	Apply lubricant (liquid soap) between stator and rotor.
X								Incorrect direction of rotation.	Check direction of rotation and swap over motor connections if necessary.
X	X	X			X	X		Suction pipe or shaft seal leaking.	Eliminate leaks.
X	X	X				X		Suction head too great.	Check the suction head, if necessary increase pipe cross section on suction pipe and use a larger filter, open suction-side valve fully.
X	X	X						Viscosity of conveying product too great.	Check/adapt (data sheet).
		X	X				X	Pump rotation speed incorrect.	Correct rotation speed (data sheet).
	X	X							Avoid air bubbles in the conveying product.
		X	X	X		X	X	Pressure head too great.	Check pressure head with pressure gauge, reduce pressure head by using larger pressure pipe crossed section or shortening the pressure pipe.
X	X	X			X		X	Pump running partially/ completely dry.	Check there is adequate conveying product available on the suction side. Dry running protection DRP.
						X	X	Check coupling.	If necessary, move pump in relation to drive, check wear on coupling gear, re-adjust coupling if necessary.
X		X						Rotation speed too low.	Increase rotation speed for low-viscosity media/large suction volume.

Malfunction									Causes	Rectification	
Pump is not sucking	Pump pumping unevenly	Conveying capacity is not achieved	Pressure head is not reached	Pump does not start up	Pump seized / pump does not pump	Pump is loud when running	Motor gets too hot	Premature stator wear			Shaft seal is leaky
X	X					X				Rotation speed too high.	Reduce rotation speed for high-viscosity media, risk of cavitation.
						X				Joint play too large.	Check mounting of coupling rod bushing.
X		X		X	X			X		Foreign objects in pump.	Dismantle pump, remove foreign bodies, replace defective parts.
X		X	X		X					Stator/rotor worn.	Dismantle pump and renew defective parts.
X		X			X	X				Joint parts worn.	Renew joint parts, use seepex pin joint grease.
X		X			X			X		Suction pipe blocked.	Clean the suction pipe.
X				X	X		X	X		Temperature of pumping liquid too high.	Check temperature, use an undersize rotor.
X		X		X			X		X	Gland packing too firm/worn.	Loosen packing gland or tighten. Renew unusable packing rings.
X				X	X			X		Solid content and/or grain size too great.	Reduce pump speed, install screen with permitted mesh width. Increase liquid proportion.
X				X				X	X	Sedimentation/gumming of solids when pump stationary.	Rinse through and clean the pump immediately.
X				X	X			X	X	Conveying product hardens when the temperature drops below a certain limit.	Heat the pump.
				X	X		X	X		Stator swollen and unable to withstand conveying product.	Select a suitable stator material, use an undersize rotor.
						X			X	Bearings in pump drive housing or drive unit defective.	Renew bearings.
									X	Mechanical seal defective.	Check sliprings and O-rings for wear/resistance, renew if necessary.



## 9.1 Pump Dismantling/Reassembly

Range: BT

Size: 05-24 up to 300-6L

### 9.1.1 Preparing the pump for dismantling

	<span style="font-size: 2em;">!</span> DANGER
<p><b>Dangerous voltage.</b> Death or serious injury can occur.</p> <ul style="list-style-type: none"> <li>➤ Note safety regulations.</li> <li>➤ Disconnect motor from all sources of energy.</li> <li>➤ Secure electrical connections against restarting.</li> </ul>	

- Empty pipelines.
- Allow pipelines to cool down.
- Remove pipeline connections (suction side/pressure side).
- Note decommissioning (→ chapter 6.4).

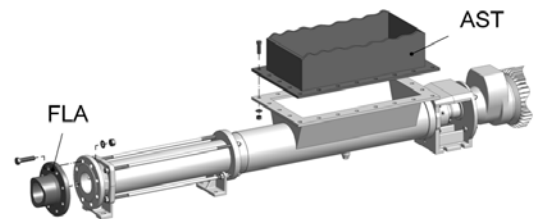

### 9.1.2 Dismantling

	<span style="font-size: 1.5em;">!</span> WARNING
<p><b>Risk of pump tipping or falling.</b> Death or serious injury can occur.</p> <ul style="list-style-type: none"> <li>➤ Fasten the lantern <b>(200)</b> to secure the pump.</li> </ul>	

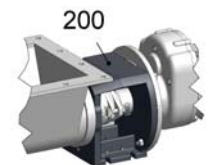

#### 9.1.2.1 Pressure branch (700) - Dismantling

- Prop up stator **(601)** with a support **(S)**.
- Remove screw fitting **(604, 606)**.
- Remove pressure branch **(700)**.
- Remove tie bolt **(602)**.

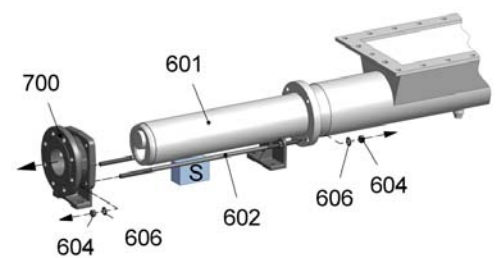

### 9.1.2.2 Stator (601) - Dismantling

- Raise/move splash ring (310).
- Remove the plug-in shaft pin (309).
- Insert tool (WS).
- Turn tool (WS) upwards.

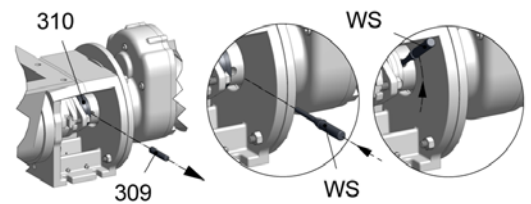

Tool (W2/chain wrench)

- Add lubricant (GM) to the opening on pressure branch side between the rotor (600) and the stator (601).
- Turn the stator (601) in the “left” rotating direction and remove.
  - Use tool (W2).
- Prop up the rotor (600) with support (S).

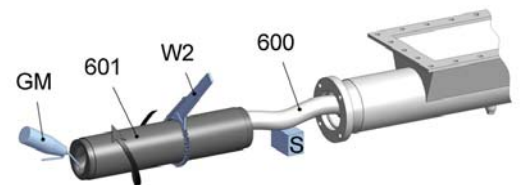

### 9.1.2.3 Feed hopper (500) - Dismantling

- Put a protective cover (SH) on the rotor (600).
- Prop up rotor (600) with a support (S).
- Remove screw fitting (507, 509).
- Remove feed hopper (500) and casing gasket (501).
- Remove tool (WS).

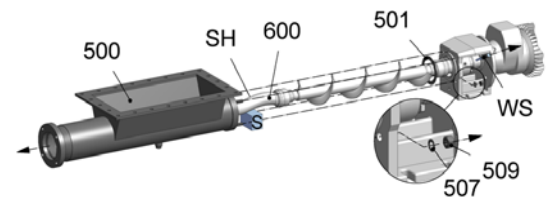

### 9.1.2.4 Rotating unit (RTE) - Dismantling



Tool (W10/dismantling tool)



Tool (W9/mounting lever)

#### with flush connection

- Remove the flush connection (SSÜ) on the shaft seal casing (SEA).

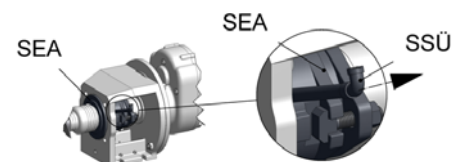

- Assemble tool (**W10**/dismantling tool).

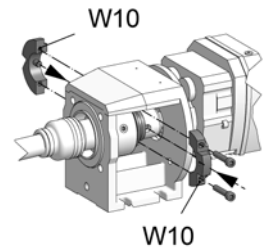

- Pull the rotating unit (**RTE**) with shaft seal (**SEA**) off from the output shaft of the drive (**ANT**).
  - Use tool (**W9**/mounting lever).

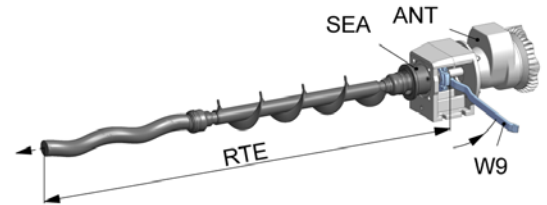

- Dismantle tool (**W10**/dismantling tool).

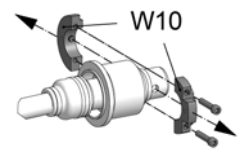

- Pull off the splash ring (**310**).
- Pull off the shaft seal casing (**SEA**).
  - Note dismantling shaft seal (→ chapter 9.4).

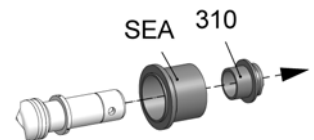

**without flush connection**

- Assemble tool (**W10**/dismantling tool).

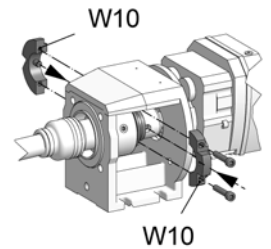

- Pull the rotating unit (**RTE**) with shaft seal (**SEA**) off from the output shaft of the drive (**ANT**).
  - Use tool (**W9**/mounting lever).

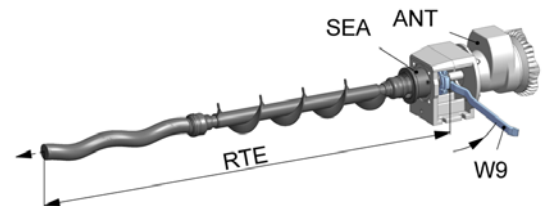

- Dismantle tool (**W10**/dismantling tool).

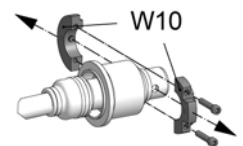

- Pull off the splash ring (**310**).
- Pull off the shaft seal casing (**SEA**).
  - Note dismantling shaft seal (→ chapter 9.4).

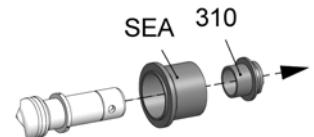

**9.1.2.5 Rotor (600), auger feed screw (400), plug-in shaft (307) - dismantling**

- Joint **(G)** dismantling note rotating unit - individual parts (→ chapter 9.2).

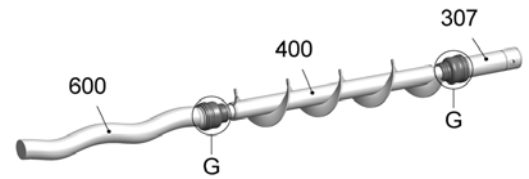

**9.1.2.6 Lantern (200)/drive (ANT) - Dismantling**

<b>CAUTION</b>
<p><b>Falling or tilting drive.</b> Slight injury can occur.</p> <ul style="list-style-type: none"> <li>➤ Secure the drive <b>(ANT)</b>.</li> </ul>

- Remove the screw fitting **(210, 212, 213)**.
- Remove the drive **(ANT)**.

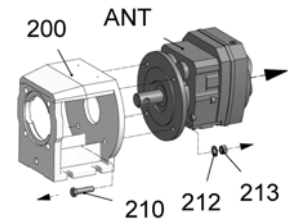

**9.1.3 Reassembly**

<b>WARNING</b>	
<p><b>Risk of pump tipping or falling.</b> Death or serious injury can occur.</p> <ul style="list-style-type: none"> <li>➤ Fasten the lantern <b>(200)</b> to secure the pump.</li> </ul>	

**9.1.3.1 Lantern (200)/drive (ANT) - Reassembly**

- Clean the flange bearing surfaces **(FLS)**, bolt circle **(ZD)** and the output shaft of the drive unit **(ANT)**.
- Mount the drive **(ANT)** to the lantern **(200)** with screw fittings **(210, 212, 213)**.

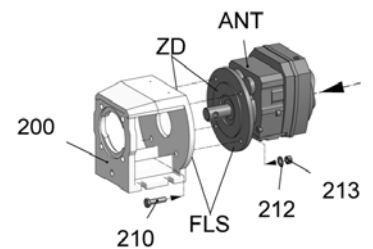

**9.1.3.2 Rotor (600), auger feed screw (400), plug-in shaft (307) - Reassembly**

- Joint **(G)** reassembly note rotating unit - individual parts (→ chapter 9.2).

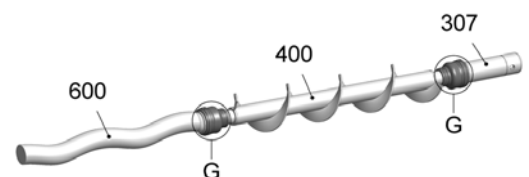

### 9.1.3.3 Rotating unit (RTE) - Reassembly

- Slide on shaft seal casing (**SEA**).
  - Note reassembly shaft seal (→ chapter 9.4).
- Moisten splash ring (**310**) and plug-in shaft (**307**) with antiseize graphite petroleum.
- Slide splash ring (**310**) onto plug-in shaft (**307**).
  - Observe fitting position of splash ring (see lettering).
- Apply antiseize graphite petroleum to the output shaft of drive (**ANT**).
- Slide on rotating unit (**RTE**).

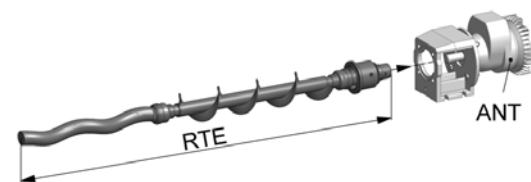
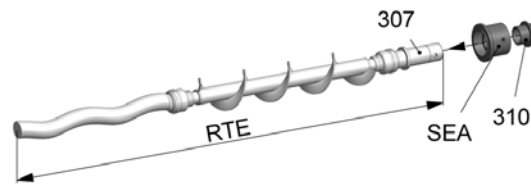

#### with flush connection

- Mount the flush connection (**SSÜ**).

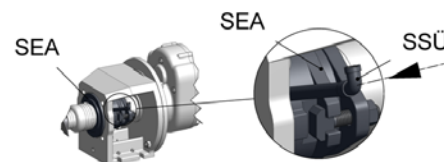

### 9.1.3.4 Feed hopper (500) - Reassembly

- Put a protective cover (**SH**) on the rotor (**600**).
- Prop up rotor (**600**) with a support (**S**).
- Push on the casing gasket (**501**).
- Mount and align the feed hopper (**500**) with screw fitting (**507, 509**).
  - Use spirit level (**W**).
- Remove the protective cover (**SH**).

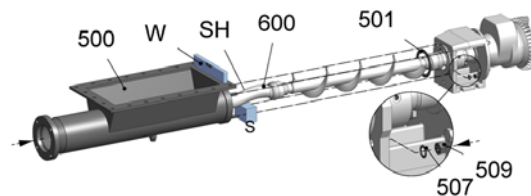

### 9.1.3.5 Stator (601) - Reassembly

- Insert tool (**WS**).
- Turn tool (**WS**) down.

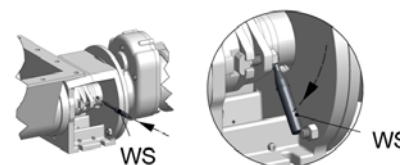



Tool (W2/chain wrench)

- Moisten outer surface of the rotor (600) with lubricant (GM).
- Moisten inner surface of the stator (601) with lubricant (GM).
- Prop up stator (601) with support (S).
- Turn stator (601) in the “right” rotating direction and slide onto rotor (600).
  - Use tool (W2).
- Remove tool (WS).
- Slide in plug-in shaft pin (309).

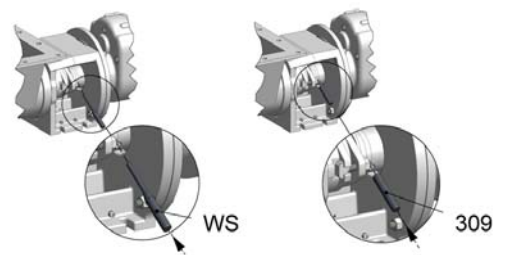
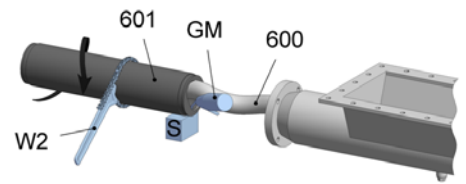

- Pay attention to the position of the splash ring (310).
- Insert the splash ring collar at a distance of 0.5 mm from the lantern (200).

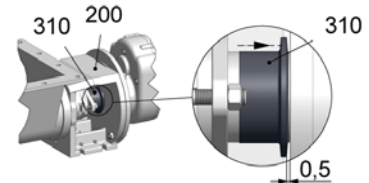

### 9.1.3.6 Pressure branch (700) - Reassembly

- Prop up stator (601) with a support (S).
- Insert tie bolts (602) loosely into the suction casing (500).
- Push pressure branch (700) on to the stator (601).
- Insert tie bolts (602) loosely in the pressure branch (700).
- Remove the support (S).
- Mount screw fitting (604, 606).
- Tighten tie bolts (602) equally.

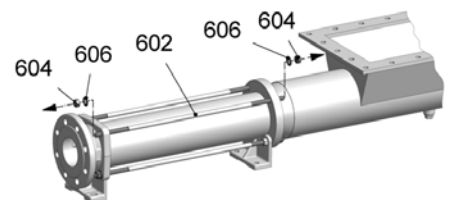
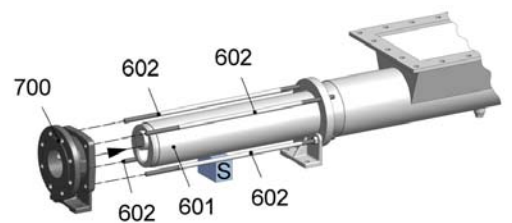
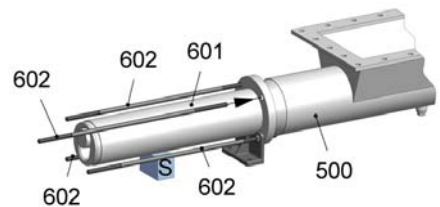

## 9.2 Rotating unit individual parts

### 9.2.1 Dismantling

#### 9.2.1.1 Holding band (406, 407) - dismantling

 <b>CAUTION</b>
<p><b>Danger of injury.</b> Parts might be thrown out.</p> <ul style="list-style-type: none"> <li>➤ Wear safety glasses.</li> </ul>

- Detach holding band loop (**SCL**).
  - Use suitable tool (**WH**).
- Push out parts of holding band loop (**SCL**).
- Remove holding band (**406, 407**).
- Pull back universal joint sleeve (**405**).

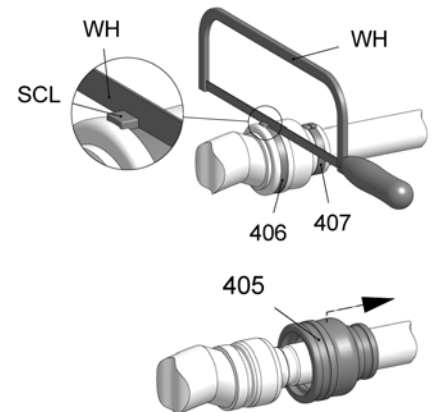

#### 9.2.1.2 Retaining sleeve (401) - dismantling

- Knock back retaining sleeve (**401**).
  - Use suitable tool (**WM**).

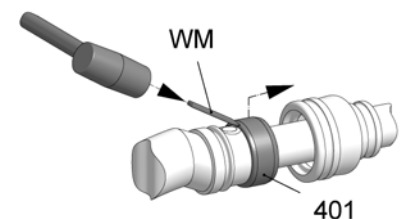

#### 9.2.1.3 Detach joint



- Eject coupling rod pins (**402**).

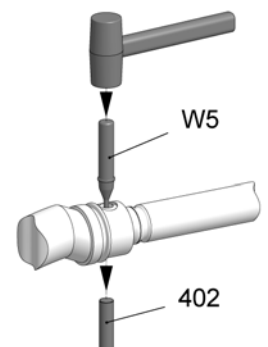

- Bend (**A**) the coupling rod (**400**). Knock guide bushing (**403**) out with tool (**W5**).

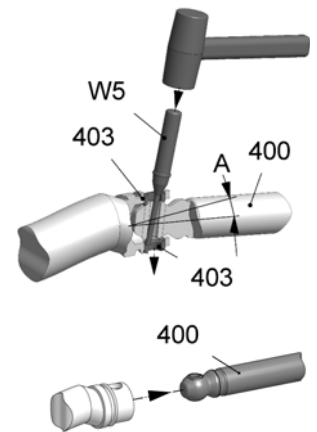

- Remove coupling rod (**400**).

## 9.2.2 Rotating unit (RTE) - prepare individual parts for reassembly

### 9.2.2.1 Rotor (600)

- Remove any damage.
- Clean rotor (**600**).

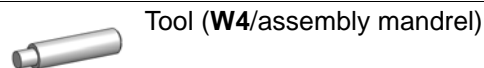

- Press in guide bushings (**403**) (depth = 2/3).
  - Use tool (**W4**).

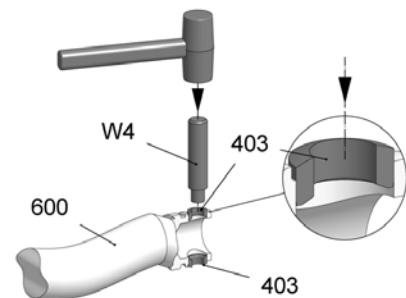

### 9.2.2.2 Coupling rod (400)

- Clean the coupling rod (**400**).
- Examine bore head for wear.
  - If wearing is detected on the bore head, replace the coupling rod (**400**).

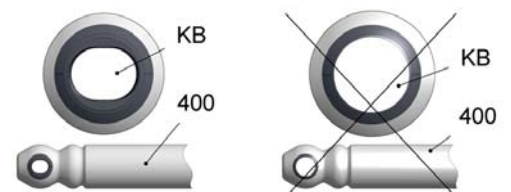



### 9.2.2.3 Plug-in shaft (307)

- Remove any damage.
- Clean rotor (600).



Tool (W4/assembly mandrel)

- Press in guide bushings (403) (depth = 2/3).
  - Use tool (W4).

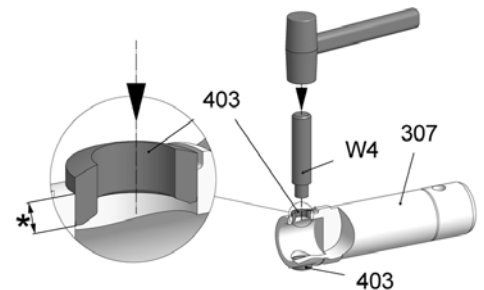

### 9.2.3 Rotating unit (RTE) - individual parts - reassembly

#### NOTICE

#### **Malfunction of the joints.**

Malfunction and/or destruction of joints.

- Replace coupling rod pins (402) and guide bushings (403) jointly.

#### 9.2.3.1 Coupling rod (400) - reassembly

- Slide the universal joint sleeve (405) and holding bands (406, 407) onto coupling rod (400).
- Fit the diameter and width of the holding band of the universal joint sleeve.
- Fill the joint head with seepex joint grease.

#### **Rotor (600)**

- Insert coupling rod pins (402).
- Slide on retaining sleeve (401).
- Connect rotor/coupling rod.

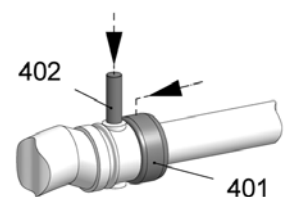
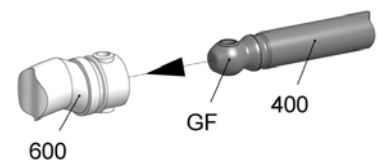

Tool (W5/drift)

- Slide in the coupling rod pins (402).
- Knock the guide bushings (403) in.
  - Use tool (W5).

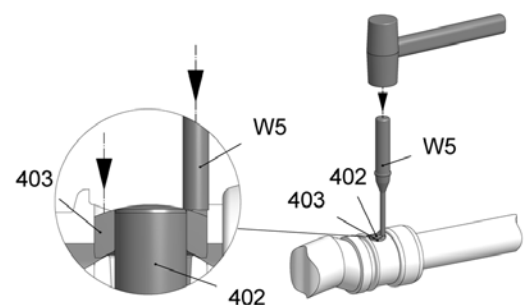

**Plug-in shaft (307)**

- Insert coupling rod pins (402).
- Slide on retaining sleeve (401).
- Connect plug-in shaft/coupling rod.

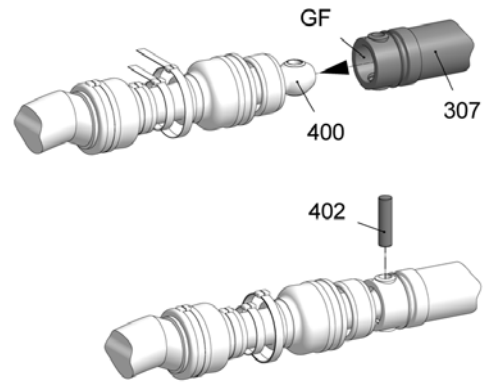

Tool (W5/drift)

- Slide in the coupling rod pins (402).
- Knock the guide bushings (403) in.
  - Use tool (W5).

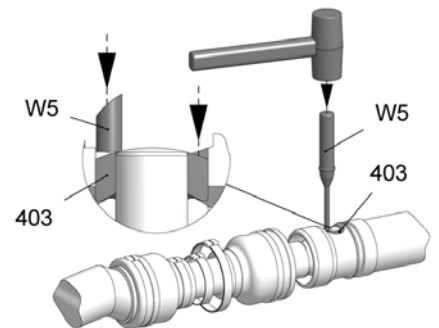

**9.2.3.2 Retaining sleeve (401) - reassembly**



Tool (W4/assembly mandrel)

- Knock back retaining sleeve (401).
  - Use tool (W4).

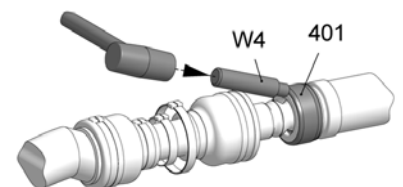

**Rotor (600) unhardened material**

- Secure retaining sleeve (401) in a displaced manner (2x180°).
  - Use suitable tool (WK).

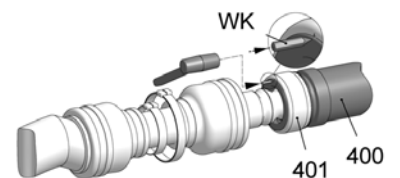

**Rotor (600) hardened material**

- Secure retaining sleeve (401) in a displaced manner (2x180°).
  - Use suitable tool (WK).

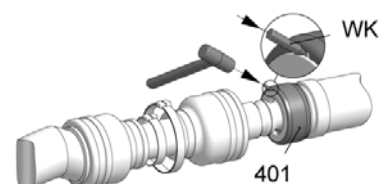

**9.2.3.3 Universal joint sleeve (405) - reassembly**

- Moisten the surface of coupling rod (**400**) / inner surface of universal joint sleeve (**405**) with joint grease (maintenance → chapter 7.).
- Slide on universal joint sleeve (**405**).
- Remove air from the inside of the joint.
  - Use suitable tool (**WS**).
- Assemble the holding band.
  - Holding band assembly (→ chapter 9).

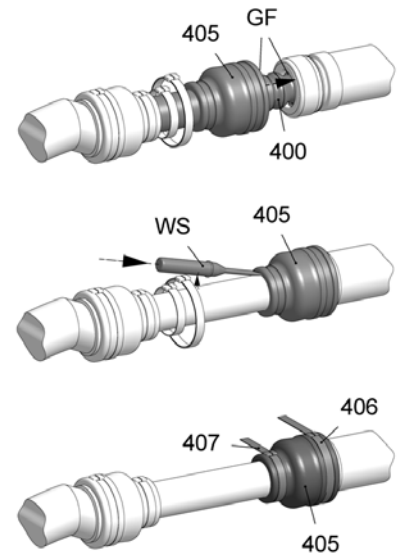



### 9.3 Holding band - assembly

#### 9.3.1 Prepare the holding band

- Only use prefabricated double-band holding bands may.

#### 9.3.2 Check the holding band

- Bent-over holding band (**HBD**) is in contact with holding band loop (**SCL**) to avoid damaging universal joint sleeve.
- Press on holding band (**HBD**) using tool (**WZ**) if necessary.

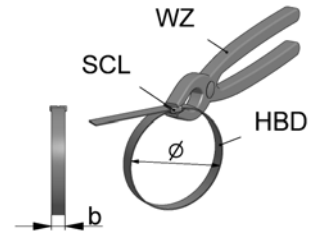

#### 9.3.3 Assemble the holding band



- Use tool (**W3**/mounting tool)

- Feed holding band into tool (**W3**).
- Hold ends of holding band with the eccentric lever (**EX**).
- Turn the crank (**KU**) until the holding band is strained and lies against the holding band loop (**SCL**).
- Carefully pull the holding band together until it is in contact with the circular groove of universal joint sleeve.

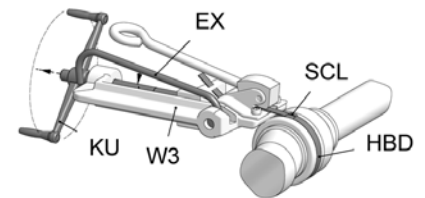

#### 9.3.4 Correct tension of holding band (HBD)

##### Correct

The holding band (**HBD**) has drawn in the out shape of the universal joint sleeve and is firmly seated.

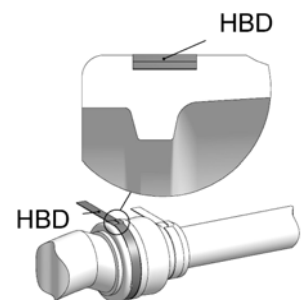

##### Incorrect

The holding band (**HBD**) is too loose, can slip off.



##### Incorrect

The holding band (**HBD**) is too tight, universal joint sleeve will be damaged/sheared off.

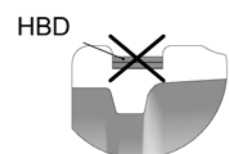

### 9.3.5 Cant up the holding band

- Swivel mounting tool (**W3**) approx. 60° upwards.
- Loosen crank (**KU**) by a half turn.
- Swivel cutting lever (**SH**) forward until the pressure piece is lying behind the holding band loop (**SCL**).

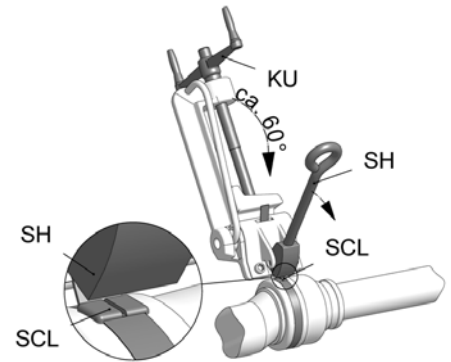

### 9.3.6 Shear the holding band (material: 1.4301; 1.4401)

- Hit the cutting lever (**SH**) with the inside of your hand.
  - Cant up and shear the end of the holding band behind the loop (**SCL**).
  - Carefully straighten up the holding band (**HBD**) if it rises up on the sheared side.

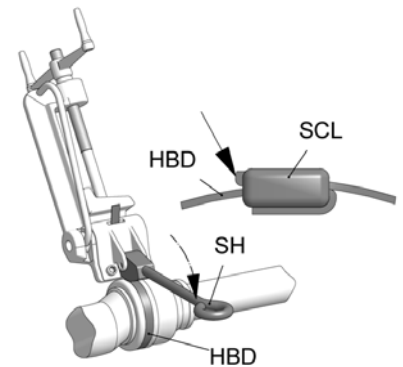

#### NOTICE

**Universal joint seal damage.**

Pin joint grease can emerge.

- Avoid hammering or striking.

### 9.3.7 Check the holding band after assembly

- The holding band must lie in the groove of the universal joint sleeve.
- Replace the holding band if the holding band slips back through the loop.

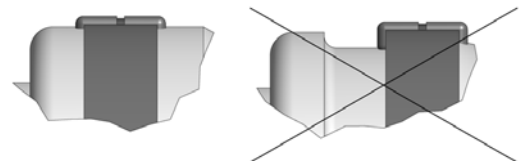

## 9.4 / 9.5 Shaft sealing

### 9.4.1 Safety

 <b>WARNING</b>	
<b>Shaft seal is leaky.</b> Leakage may escape into the atmosphere.	
<ul style="list-style-type: none"><li>➤ Take safety measures to protect persons and the environment.</li><li>➤ Wear suitable protective clothing.</li><li>➤ Dispose of leakage appropriately.</li><li>➤ Note applicable regulations when handling hazardous substances.</li></ul>	

### 9.4.2 Operating conditions and material combination

- Adjust to the relevant application
  - Design variants you will find at <http://www.seepex.com/en/service/downloads/>.





10.1 Spare parts list



**Version for copying**

**10.1 Spare parts list**

Spare parts can be ordered online or requested from  
[www.seepex.com](http://www.seepex.com)

**Type: BT 05-24 to 300-6L**

Request  Order

**Sender:**

**Must be included in every order or enquiry!**

**Commission:**

**Type:**

Contact: .....

Tel.: .....

Fax: .....

E-mail: .....

**Customer service:**  
seepex GmbH  
Postfach 10 15 64  
D-46215 Bottrop  
service@seepex.com

**Germany**

Tel +492041.996-231  
Fax +492041.996-431

**Rest of Europe**

Tel +492041.996-224  
Fax +492041.996-424

**Outside Europe**

Tel +492041.996-120  
Fax +492041.996-432

**Delivery address:**

.....  
.....  
.....  
.....

No.	Quantity	Component	Material	Comment
<b>Minor set of wearing parts</b> <input type="checkbox"/>				
301	1	Set of packing rings		according to data sheet (chapter 3.1)
311	1	Flushing ring		
330	1	Mechanical seal		according to data sheet (chapter 3.1)
601	1	Stator		

<b>Major set of wearing parts</b> <input type="checkbox"/>				
301	1	Set of packing rings		according to data sheet (chapter 3.1)
307	1	Plug-in shaft		
311	1	Rinse ring		
330	1	Mechanical seal		according to data sheet (chapter 3.1)
400	1	Coupling rod with coupling rod bushings		
402	2	Coupling rod pin		
403	4	Guide bushing		
405	2	Universal joint sleeve		
406	2	Holding band, large		
407	2	Holding band, small		
600	1	Rotor		
601	1	Stator		

Place, date

Signature / company stamp

Version for copying

No.	Quantity	Component	Material	Comment
<b>Set of gaskets</b> <input type="checkbox"/>				
301	1	Set of packing rings		according to data sheet (chapter 3.1)
310	1	Splash ring		according to data sheet (chapter 3.1)
330	1	Mechanical seal		
501	1	Casing gasket		
503	3	Sealing ring		
706	1	Sealing ring		
<b>Plug-in shaft &amp; shaft seal</b> <input type="checkbox"/>				
301		Set of packing rings		according to data sheet (chapter 3.1)
307		Plug-in shaft		
309		Plug-in shaft pin		
310		Splash ring		according to data sheet (chapter 3.1)
330		Mechanical seal		according to data sheet (chapter 3.1)
<b>Coupling rod &amp; joint parts</b> <input type="checkbox"/>				
400		Coupling rod with coupling rod bushings		
401		Retaining sleeve		
402		Coupling rod pin		
403		Guide bushing		
405		Universal joint sleeve		
406		Holding band, large		
407		Holding band, small		
401-407		Complete set of joint parts		
<b>Conveying elements</b> <input type="checkbox"/>				
600		Rotor		
601		Stator		
<b>Miscellaneous parts</b> <input type="checkbox"/>				
501		Casing gasket		
098		Pin joint grease		1 cartridge = 300 g (approx. 315 cm <sup>3</sup> ) Grease quantity according to maintenance (chapter 7.0)

Place, date

Signature / company stamp

**Version for copying**

Spare parts can be ordered online or requested from  
[www.seepex.com](http://www.seepex.com)

**Must be specified with every order!**

Commission:

\_\_\_\_\_

Mark tool!

Sender:

Contact: .....

Tel.: .....

Fax: .....

E-mail: .....

**Customer service:**

seepex GmbH  
Postfach 10 15 64  
D-46215 Bottrop  
service@seepex.com

**Germany**

**Rest of Europe**

**Outside Europe**

Tel +492041.996-231

Fax +492041.996-431

Tel +492041.996-224

Fax +492041.996-424

Tel +492041.996-120

Fax +492041.996-432

**Delivery address:**



.....



.....

.....

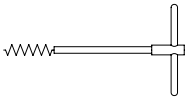
.....

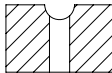
.....

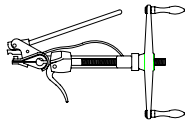
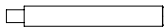
For installation of:	Packing gland	Stator	Coupling rod bushings	
Tool no.	W1 <input type="checkbox"/>	W2 <input type="checkbox"/>	W14 <input type="checkbox"/>	
Denomination:	Packing lever	Chain pipe wrench + replacment chain	Pressing tool	
Order no.	PKZ	KRZ	PWZ	
				

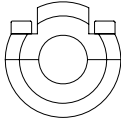
For installation of:	Rotating unit			
	Holding band	Joint	Joint	Plug-in shaft
Tool no.	W3 <input type="checkbox"/>	W4 <input type="checkbox"/>	W5 <input type="checkbox"/>	W10 <input type="checkbox"/>
Denomination:	Mounting tool	Assembly mandrel	Drift	Dismantling tool
Order no.	MHB	MTD	DHS	AZV
				

For installation of:	General			
Tool no.	W9 <input type="checkbox"/>			
Denomination:	Mounting lever			
Order no.	MHL			
				



### 12.1 Accessories/Technical information

- Accessories and technical information are commission specific documents not part of this not binding operating and assembly instruction.





**13.1 Manufacturer's and supplier's documents**

- Manufacturer's and supplier's documents are commission specific documents and not part of this not binding operating and assembly instruction.





**Great Britain**

SEEPEX UK Ltd.  
3 Armtech Row  
Houndstone Business Park  
Yeovil Somerset BA22 8RW  
Tel +44.1935.472376  
Fax +44.1935.479836  
sales@seepex.co.uk

**Austria**

SEEPEX GmbH  
Vertriebsbüro Österreich  
Obermüllergasse 18  
3003 Gablitz  
Tel +43.2231.61085  
Fax +43.2231.6108520  
hfriedl@seepex.com

**Belgium**

SEEPEX GmbH  
Bureau België  
Industriezone Klein Gent-Link 21  
Welvaartstraat 14-1 bus 15  
2200 Herentals  
Tel +32.14.501471  
Fax +32.14.501461  
seepex.be@seepex.com

**Denmark**

SEEPEX Nordic A/S  
Krakasvej 7C  
3400 Hillerød  
Tel +45.49.192200  
Fax + 45.49.193200  
info.nordic@seepex.com

**France**

SEEPEX France SARL  
1, Rue Pelloutier  
77183 Croissy Beaubourg  
Tel +33.1.64114450  
Fax + 33.1.64114489  
info.fr@seepex.com

**Hungary**

SEEPEX GmbH  
Magyarországi iroda  
Hecskó Tamás okl.vill.mérn.  
Éva utca 5.  
7632 Pécs  
Tel +36.205806134  
Fax +36.72952587  
thcsko@seepex.com

**Ireland**

SEEPEX UK Ltd.  
Branch Office Ireland  
29 Lackenfune  
Dungarvan  
Co. Waterford  
Tel +353.860450439  
sales@seepex.co.uk

**Italy**

SEEPEX Italia S.r.l.  
Via Alberto da Giussano 23  
20145 Milano (MI)  
Tel +39.02.36569360  
Fax +39.02.92877855  
info.it@seepex.com

**Poland**

SEEPEX GmbH  
Przedstawicielstwo w Polsce  
ul. Romana Maya 1  
61-371 Poznan  
Tel +48.61.6469270  
Fax +48.61.6469271  
info.pl@seepex.com

**Sweden**

SEEPEX Nordic A/S  
Hamndalsvägen 58  
61633 Åby  
Tel +46.1166940  
Fax +46.1166941  
info.nordic@seepex.com

**Spain**

SEEPEX GmbH  
Oficina de Representación en España  
C/Copenhague, 12  
Edif. Tifan Oficina 207  
28232 La Rozas  
Madrid  
Tel +34.91.6361353  
Fax +34.91.6409371  
info.es@seepex.com

**The Netherlands**

SEEPEX GmbH  
Bureau Nederland  
Visbystraat 13  
7418 BE Deventer  
Tel +31.570.516644  
Fax +31.570.516077  
seepex.nl@seepex.com

**Russia**

SEEPEX Ltd. Ugreshskaya  
Str. 2 Bldg. 23  
115088 Moscow  
Tel +7.495.2874830  
Fax +7.495.2874830  
info.cis@seepex.com

**USA**

SEEPEX Inc.  
511 Speedway Drive  
Enon  
Ohio 45323  
Tel +1.937.8647150  
Fax + 1.937.8647157  
sales@seepex.net

**China**

SEEPEX Pumps (Shanghai) Co., Ltd.  
Xuanzhong Rd. 399, Building 13  
Nanhui Industrial Area  
201300 Shanghai  
Tel +86.21.38108888  
24-Hour Helpline +86.400.7701066  
Fax +86.21.38108899  
info.cn@seepex.com

**India**

SEEPEX India Pvt. Ltd.  
Office No. 305.  
Raheja Arcade Building  
Sector 11, C.B.D. Belapur  
Navi Mumbai 400614  
Tel +91.22.40240434/35  
Fax +91.22.40240436  
info.ind@seepex.com

**Japan**

日本シーベックス株式会社  
German Industry Park  
1-18-2 Hakusan, Midori-ku  
Yokohama 226-0006  
Tel +81.46.2595931  
Fax +81.46.2595941  
info.jp@seepex.com

**Malaysia**

SEEPEX (M) Sdn. Bhd.  
No. 2, Jalan 51/203A  
Kaw. Perindustrian Tiong Nam  
Seksyen 51  
46050 Petaling Jaya  
Selengor Darul Ehsan  
Tel +60.3.88009988  
seepex.m@seepex.com

**Australia**

SEEPEX Australia Pty. Ltd.  
Unit 3, 4 Bounty Close  
Tuggerah Business Park  
NSW 2259  
Tel +61.2.43554500  
Fax +61.2.43554022  
info.au@seepex.com