

Not Binding Operating and Assembly Instruction Progressive Cavity Pump

This operating and assembly instruction is only
for general information.

Type
BCSO 025-24 to 130-6L
Q] ^ } Á ã Á ã d

1	Safety	1
1.1	General notes	
1.2	Safety and warning notes	
1.2.1	Warning notes	
1.2.2	Danger symbols	
1.2.3	Information symbols	
1.3	Dangers that can be caused by the machine	
1.4	Qualification of the personnel	
1.5	Authorised people	
1.5.1	Tasks and information for the owner/operators	
1.5.2	Safety notes for maintenance, inspection and assembly work	
1.6	Personal protective equipment	
1.7	Safety and protective devices	
1.8	Foreseeable misuse	
1.9	Designated use	
1.10	Warranty	
2	Description of the pump	5
2.1	General description	
2.2	Mode of action and pumping principle of the pump	
2.3	Constructive design	
3	Technical Data	6
4	Transport, Intermediate storage, Disposal	8
4.1	Safety	
4.2	Transport	
4.2.1	Dimensions, weight and centre of gravity	
4.2.2	Symbol	
4.2.3	Lashing points (AP) for lifting devices	
4.2.4	Unpacking the machine	
4.3	Temporary storage/corrosion protection	
4.4	Disposal	

5	Assembly / Installation.....	11
5.1	Mounting tools / lifting gear	
5.2	Space requirement	
5.2.1	Dimension for stator replacement	
5.3	Assembly of the complete mounted pump	
5.4	Power supply of the pump	
5.5	Pipelines	
5.5.1	Suction and pressure connection	
5.5.2	Pipeline dimensions	
5.5.3	Residue-free pipelines	
5.5.4	Tension-free assembly	
6	Commissioning / De-Commissioning.....	13
6.1	Commissioning report.....	13
6.2	Measures before commissioning.....	14
6.2.1	Checking pipelines	
6.2.2	Protective devices on the pump	
6.2.3	Electrical / hydraulic connections	
6.2.4	Direction of rotation check	
6.2.5	Additional devices - optional	
6.3	Initial commissioning/repeated commissioning	
6.3.1	Avoiding dry running of the pump	
6.3.2	Pressure in the suction and pressure connection	
6.4	De-commissioning	
6.4.1	Switching off the pump	
6.4.2	Emptying the pump	
6.4.3	Dismantling the pump	
6.4.4	Preservation/storage of the pump	
7	Maintenance.....	19
7.1	Preventative measures	
7.1.1	Pump down-time	
7.2	Lubrication	
7.2.1	Joint grease	
7.3	Inspection	
7.4	Cleaning of CS pumps.....	21
8	Malfunctions, causes, rectification.....	26
9	Pump Dismantling / Reassembly.....	29
9.1.1	Prepare the pump for dismantling	
9.1.2	Dismantling	
9.1.3	Reassembly	

9.2	Rotating unit – individual parts	35
9.2.1	Dismantling	
9.2.2	Rotating unit (RTE) - prepare individual parts for reassembly	
9.2.3	Rotating unit (RTE) - individual parts - reassembly	
9.4	Mechanical seal	38
9.4.1	Safety	
9.4.2	Application conditions and material version	
9.4.3	Design	
9.4.4	Commissioning	
9.4.5	Monitoring during operation	
9.4.6	Dismantling of mechanical seal	
9.4.7	Reassembly of mechanical seal	
10	Spare parts.....	40
10.1	Order template for spare parts.....	42
11	Special tools	46
12	Related documents	48
13	Appendix.....	50
13.1	Manufacturer's documents / suppliers	

Subsidiaries

1.1 General notes

- Always keep the operating and maintenance instructions close by the machine.
- If problems cannot be solved with reference to the operating and maintenance instructions, please contact the manufacturer.

Observe the following points in addition to these operating and maintenance instructions:



- Prohibition, warning and mandatory signs, warning notes on the machine
- Relevant laws and ordinances
- Statutory provisions on accident prevention
- Corresponding harmonised standards and regulations

1.2 Safety and warning notes

- Comply with safety and warning notes for safe and efficient use of the product.

Signal words for specific dangers and (possible) consequences are explained below. These are supplemented by symbols (pictograms) if necessary.

1.2.1 Warning notes

NOTICE
<p>Caution for machine! Possible danger. Material damage can occur.</p>
 CAUTION
<p>Caution for people and machine! Possible danger. Minor injury or damage to property can occur.</p>
 WARNING
<p>Warning for people! Possible danger. Death or serious injury can occur.</p>
 DANGER
<p>Danger for people! Possible danger. Immediate risk of sever or fatal injury.</p>

1.2.2 Danger symbols



Warning:
Suspended load.



Warning:
Dangerous electrical
voltage.

1.2.3 Information symbols

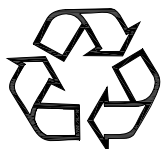

Ensure environmental protection. Wear eye protection.

- Instruction to act/take measures
- List item

1.3 Dangers that can be caused by the machine

seepex machines are built in accordance with the state of the art.

Nevertheless, there is a residual risk, because the machine works with:

- Mechanical movements that pose a danger
- Electrical voltages and currents

We have used design measures and applied safety technology to minimise the risk to the health of people posed by this danger.

1.4 Qualification of the personnel

This handbook is intended for:

- Owner
- Operators
- Setters
- Maintenance personnel

1.5 Authorised people

People authorised to undertake operation, set up and maintenance are instructed and trained specialists employed by the owner/manufactururer.

Detailed technical knowledge is essential for performing any work on the machine.



The owner is responsible for:

- Personnel training
- Compliance with safety regulations
- Compliance with operating and maintenance instructions

The operator must:

- Have received instruction
- Read and understood the relevant parts of the operating instructions before starting work
- Know the safety devices and regulations

1.5.1 Tasks and information for the owner/operators

- Regularly check and maintain the machine, replacing all parts in good time which no longer guarantee safe operation.
- It is essential to comply with the procedure described in the operating instructions for shutting down the machine.
- On completion of work, attach all safety and protective devices and make sure they are functioning.

1.5.2 Safety notes for maintenance, inspection and assembly work

- Do not work on the machine or system unless it is stationary and depressurised.
- Switch off the master switch and pull out the power plug before starting work on live components.
- Comply with the procedure for shutting down the machine as described in the Shut-down chapter.
- Decontaminate (de-toxify) machines that are used for pumping media that can be harmful to health.
- Refer to the Initial start-up chapter before repeated start-up of the machine.

1.6 Personal protective equipment

- Wear personal protective equipment and/or additional equipment for your own safety.
- Avoid/limit risks by the use of collective technical protective equipment or by organisational measures at work.

1.7 Safety and protective devices

- Prior to start-up, bolt seepex machines onto a concrete foundation so as to ensure stability.
- Starting and stopping devices must be clearly recognisable. Take appropriate measures to avoid defects.
- No protective device is necessary for checking and/or setting the shaft seal.
- Hot surfaces are identified with a danger symbol on the machine.

1.8 Foreseeable misuse

Serious personal injury and damage to property can be caused by:

- Incorrect use
- Incorrect installation or operation of the machine
- Impermissible removal of necessary protective equipment

1.9 Designated use

- Only use seepex machines if they are in perfect condition and in compliance with the operating and maintenance instructions.
- Do not start up the machine unless the system in which the machine is installed is in accordance with the provisions of the applicable guidelines and statutory regulations.
- Equivalent sustained sound pressure level at workplaces of operating personnel C75 dB (A). Cavitation-free operation of the machine and screwed connection to concrete foundation are essential.
- seepex machines are components that are exclusively intended for pumping media in accordance with the technical data (→ chapter 3). Written approval must be obtained from the manufacturer before other media are pumped.
- Refer to the information on the type plate and the operating instructions for technical data (→ chapter 3), and comply with them.
- The operating instructions are assigned to the seepex machine based on the commission number.

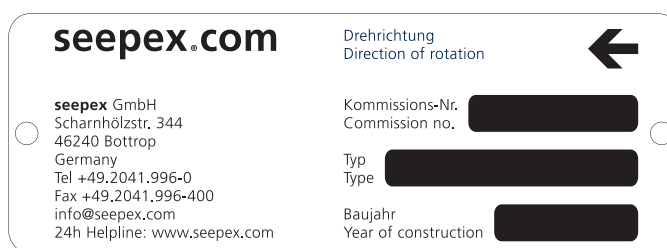

Fig. 1-1 Similar illustration

1.10 Warranty

- Warranty in accordance with our terms and conditions of delivery and order confirmation.
- It is a condition of the machine warranty that the machine must correspond to the listed operating instructions in accordance with the type plate/data sheet.
- All wearing parts are excluded from the warranty.
- These operating instructions are subject to copyright. Reproduction is not permitted and will be punished. Contravention will be pursued through the courts.

2.1 General description

seepex pumps are members of the group of rotating displacement pumps.

- Characteristic features
 - Special configuration/arrangement of the rotor and stator pumping elements.
 - Motion sequence

2.2 Mode of action and pumping principle of the seepex pump

- Sealing bands are produced through geometric design/contact of both conveying elements.
- Sealing bands ensure a perfect fit between the suction and pressure side.
Result:
 - Increased pump suction.
 - Higher pressure build-up independent of speed possible.

2.3 Constructive design

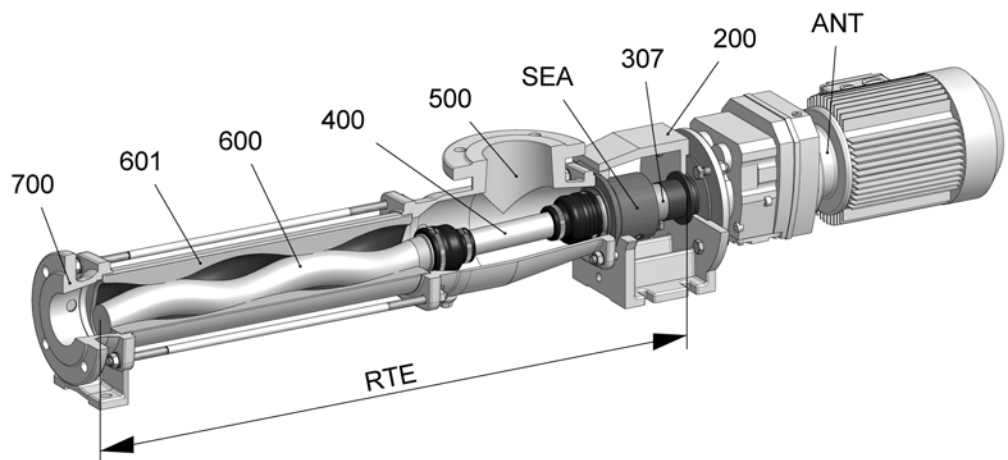

No.	Designation
ANT	Drive
200	Lantern
307	Plug-in shaft
400	Coupling rod
SEA	Shaft seal
500	Suction casing
600	Rotor
RTE	Rotating unit
601	Stator
700	Pressure branch

3.1 Data sheet

3.2 Characteristic Curves

3.3 Declaration

- Data sheet, characteristic curves and declarations are commission specific documents and not part of this not binding operating and assembly instruction.

4.1 Safety

CAUTION
<p>Damage to property/injuries due to incorrect transport Slight injury or damage to property can occur</p> <ul style="list-style-type: none"> ➤ Comply with the safety notes and transport notes on the packaging. ➤ Use suitable means of transport, lifting devices and tools. ➤ Use protective equipment.

4.2 Transport

4.2.1 Dimensions, weights and center of gravity

- Note the dimensional drawing (→ chapter 5.6).

4.2.2 Symbols

- Meaning of symbol

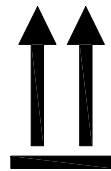

Top



Fragile
item



Against moisture
protect

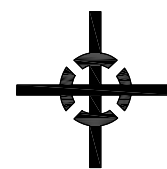

Centre of gravity



Lashing points

4.2.3 Sling points (AP) for lifting devices

	WARNING
	<p>Warning of suspended load. Death or serious injury can occur.</p> <ul style="list-style-type: none"> ➤ Use the lashing points (AP) for lifting devices. ➤ Note the centre of gravity (→ dimensional drawing, chapter 5.6).

Lifting machine

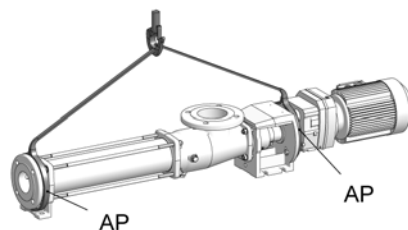

Industrial trucks

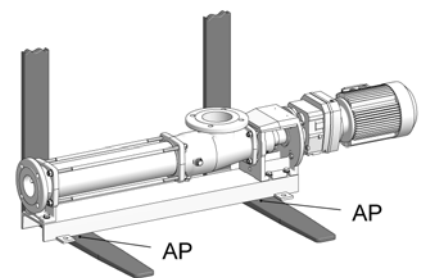

4.2.4 Unpacking the machine

- Comply with the symbols and notices on the packaging.
- Remove the screwed connection between the machine and packaging.
- Remove the machine with a lifting machine/industrial truck.

4.3 Temporary storage/Corrosion protection

- All seepex machines have corrosion protection applied as standard prior to transport.

<i>NOTICE</i>	
	<p>Damage to property if corrosion protection is missing Property damage can occur due to corrosion.</p> <ul style="list-style-type: none">➤ Temporary storage must be in a dry, enclosed, frost-free room in order to provide protection against ambient influences.➤ Contact seepex regarding the necessary corrosion protection for temporary storage.

4.4 Disposal

	<i>NOTICE</i>
	<p>Environmental protection Material damage can occur.</p> <ul style="list-style-type: none">➤ Drain the pumping medium and dispose of it in accordance with the regulations.➤ Dispose of the machine with regard to its composition and existing regulations.

5.1 Mounting tools / lifting gear

 CAUTION	
<p>Pump falling over. Slight injury or damage to property can occur.</p> <ul style="list-style-type: none"> ➤ Adhere to the lifting tool's starting point. ➤ Pay attention to the dimensions, weight and centre of gravity of the pump. ➤ Use suitable mounting tools/lifting gear. 	

5.2 Space requirement

The required space should be determined by considering the following factors:

- Dimensions and weight.
- Requisite transport and lifting equipment.
- Pipe routing – dismantling (dimension for stator replacement).

5.2.1 Dimension for stator replacement (P)

- Refer to the dimensional drawing.

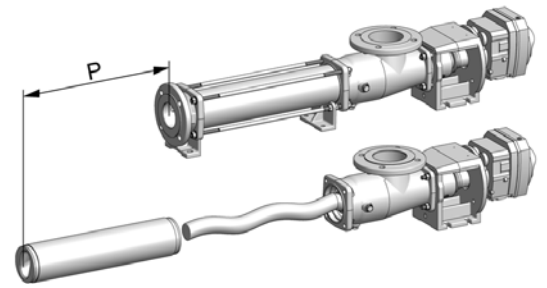

5.3 Assembly of the complete mounted pump

- Assemble according to technical data (→ chapter 3.).
- Note dimensional drawing.

Tension-free mounting of the pump

- Balance unevenness with suitable supports.
- Applies to mounting on foundations/load-bearing elements.
- Total areas of all pump bearing areas are resting on the surface.

Correct position of the drives

- All drives are set up ready for operation and mounted.
- Correct displacements of the drive during transport/installation of the pump by adjusting/fixing the drive.

 CAUTION	
<p>Safety protection equipment. Slight injury or damage to property may result.</p> <ul style="list-style-type: none"> ➤ Connect safety protection equipment and activate. 	

5.4 Power supply of the seepex pump

	! DANGER
	<p>Supply voltage and power frequency. Death or serious injury will result.</p> <ul style="list-style-type: none">➤ Heed type plate on the pump.➤ Pay attention to manufacturer's directions (→ chapter 13.).➤ Pay attention to safety regulations.

5.5 Pipelines

5.5.1 Suction and pressure connection

- Refer to the dimensional drawing for the position, nominal width and standard.
- Note direction of rotation/flow direction.

5.5.2 Pipeline dimensions

- Adhere to specifications regarding pressure in the pressure respectively suction connection.
- Note technical data (→ chapter 3.).
- Nominal width of suction pipe = nominal width of suction connection of pumps.

5.5.3 Residue-free pipelines

NOTICE
<p>Damage to property through assembly residue. No claims under guarantee if violated.</p> <ul style="list-style-type: none">➤ Keep all pipe work free of foreign objects.➤ Remove weld spatters, screws, steel chips etc.

5.5.4 Tension-free assembly

- Assemble pipelines and other components in a tension-free manner on the pump.

Master Copy

6.1 Commissioning report

Send commissioning report online to
www.seepex.com

Must be specified with every order!

Commission:

Model:

From:

Contact person:
 Tel.:
 Fax:
 E-mail:

Customer Service:

seepex GmbH
 Postfach 10 15 64
 D-46215 Bottrop
 service@seepex.com

Germany

Phone:+49 2041.996-231
 Fax: +49 2041.996-431

Rest of Europe

Phone:+49 2041.996-224
 Fax: +49 2041.996-424

Outside Europe

Phone:+49 2041.996-120
 Fax: +49 2041.996-432

Address of plant:

.....

Delivery date:

Date of installation:

Assembly check carried out on:

Please enter operational data:

Conveying liquid:

Temperature:

Fuse level/motor protection or power consumption

Frequency control

no

yes

If yes:

Supplied by seepex

Supplied by customer

Frequency:

Speed:

Power consumption:

Place, date

Signature / company stamp

6.2 Measures before commissioning

- Note the technical data (→ chapter 3.).

6.2.1 Checking pipelines

- Check flange screwed connections (**SCH**).

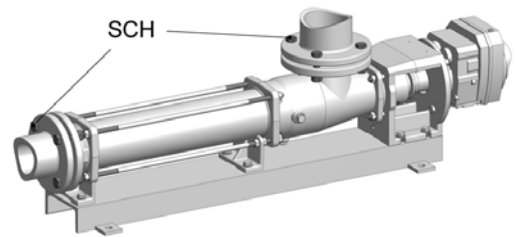

- Check threaded connections (**G**).

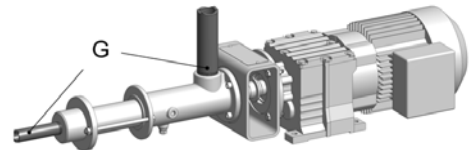



NOTICE
<p>Ensure the liquid can flow through without obstruction. Malfunction and/or irreparable damage to the pump.</p> <ul style="list-style-type: none"> ➤ Open all shut-off elements before switching on the pump.

6.2.2 Protective devices on the pump

 DANGER
<p>Missing protective device. Danger of pulling in and crushing.</p> <ul style="list-style-type: none"> ➤ Equip the pump with a protective device. Protective devices provided for preventing contact with surfaces or moving parts must be regarded as suitable if contact is not possible in a test involving a test finger, with regard to the penetration possibility, strength and shock resistance. ➤ Comply with national protection regulations. ➤ In pumps with an open suction flange/feed hopper, attach touch protection. These safety clearances protect those persons who are attempting to reach danger areas without additional help and under the conditions defined for various situations of reaching up, reaching under or reaching through <p>In shaft seals, touch protection is only necessary if there are components on the rotating shaft.</p>

6.2.3 Electrical/hydraulic connections

	 DANGER
	<p>Dangerous voltage. Death or serious injury can occur.</p> <ul style="list-style-type: none"> ➤ Note safety regulations. ➤ Disconnect motor from all sources of energy. ➤ Secure electrical connections against restarting.

6.2.4 Direction of rotation check

- The pump direction of rotation determines the flow direction of the pumping medium.
- Note the direction of rotation arrow on the type plate.

flow direction

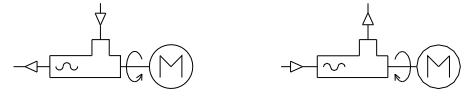

counter clockwise

clockwise

6.2.5 Additional devices - optional

- Refer to additional devices (→ chapter 12.1).

6.3 Initial commissioning/repeated commissioning

- Start up the pump.

NOTICE

Dry running of the pump.

Malfunction and/or irreparable damage to the pump.

- Fill the suction casing with liquid in order to lubricate the pumping elements.

6.3.1 Avoid dry running of the pump

NOTICE

High temperature between rotor and stator.

Stator material burned.

Complete failure of the pump.

- Make sure that the suction-side conveying capacity does not cavitate.
- If this cannot be guaranteed on the machine side, assemble a seepex dry running protection (TSE).

6.3.2 Pressure in the suction and pressure connection



CAUTION

High pressure.

Malfunction and/or irreparable damage to the shaft seal or pump.

- Maintain pressure in the suction connection in accordance with the technical data (→ chapter 3.).

Recommendation:

- Assemble an oil-filled contact pressure gauge to monitor and deactivate the pump.

6.4 De-commissioning

Protect the pump and additional devices against the following:

- Frost
- Deposit of solids
- Sedimentation from the liquid
- Corrosion of parts that come into contact with the medium

6.4.1 Switching off the pump

	! DANGER
	Dangerous voltage. Death or serious injury can occur. <ul style="list-style-type: none">➤ Note safety regulations.➤ Disconnect motor from all sources of energy.➤ Secure electrical connections against restarting.

6.4.2 Emptying the pump

! CAUTION
Liquid draining out. Minor injury or damage to property can occur. <ul style="list-style-type: none">➤ Wear suitable protective clothing.➤ Refer to the technical data (→ chapter 3.) for the corresponding configuration of the pump housing.

To drain the pump:

- If the pump housing has screwed plugs, remove the screwed plugs.
- Drain using a connection branch (suction casing, pressure branch) if the pump housing is coated or the housing does not have screwed plugs.
- Drain the residual liquid from the pump housing.
- Drain the pipelines on the suction and pressure sides, or shut off behind the pump connections.

6.4.3 Removing the pump

**WARNING****Risk of pump tipping or falling.**

Death or serious injury can occur.

- Support the drive unit to guarantee stability.

Pipeline dismantling

- Remove flange bolts (**SCH**) and flange seals (**DFL**).

with/without base plate

- Remove bolts (**SCH**) from the pump feet.

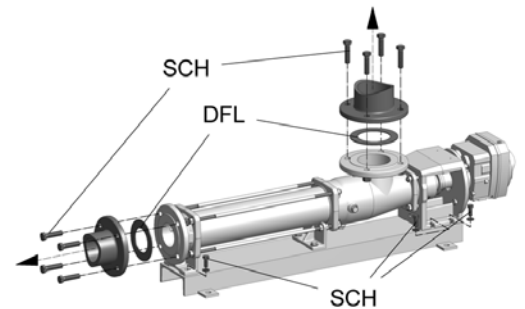
**Pipeline dismantling**

- Remove threaded connections (**G**).

with/without base plate

- Remove bolts (**SCH**) from the pump feet.

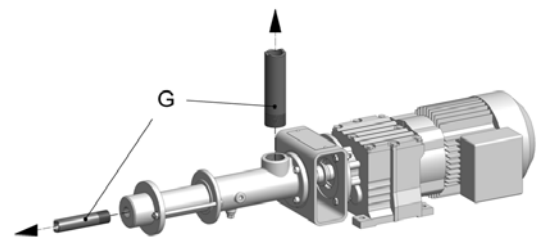

6.4.4 Preservation/storage of the pump

NOTICE**Damage to property due to lack of corrosion protection.**

Property damage can occur due to corrosion.

- Contact seepex to discuss suitable preservation measures.
 - State the commission number of the pump.

7.1 Preventive measures



The maintenance personnel must have these operating instructions, follow them and also require corresponding qualifications.

	! DANGER
	<p>Dangerous voltage. Death or serious injury can occur.</p> <ul style="list-style-type: none"> ➤ Note safety regulations. ➤ Disconnect pump from all sources of energy. ➤ Secure electrical connections against restarting.

7.1.1 Pump down-time

NOTICE
<p>Pump down-time. Production failure due to wear.</p> <ul style="list-style-type: none"> ➤ Acquisition of a set of wearing parts and a set of gaskets.

7.2 Lubrication

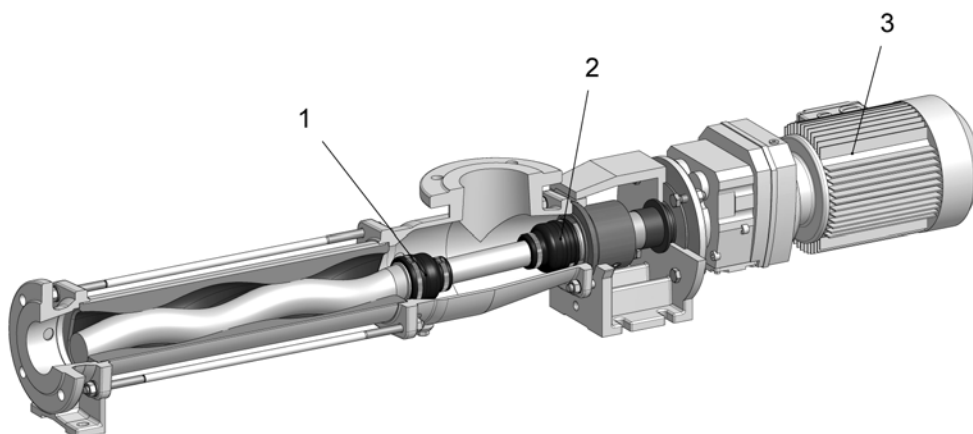

No.	Denomination	Lubricant	Lubricant change in operating hours	Fill volume
1	Pin joint	seepex special grease *	10000 h	*
2	Pin joint	seepex special grease *	10000 h	*
3	Drive	Refer to manufacturer's documentation (chapter 13._)		
	Rotor/stator	Conveying medium	---	---
	Shaft seal	Conveying medium	---	---

* Type and filling quantities are commission specific information.

7.2.1 Joint grease

NOTICE
<p>Other grease types. Malfunction and/or irreparable damage to the joints or the pump.</p> <p>➤ Exclusively use seepex special grease.</p>

7.3 Inspection

Component	Interval	Action
Joints	Every 10,000 operating hours	Renew joint grease
Stator	Every week	Visual check for leaks
Shaft seal	Every week	Visual check for leaks
Drive unit	Every 3000 operating hours, at least every 6 months	Comply with manufacturer's documentation

7.4 Cleaning of CS pumps

7.4.1 Application

- seepex pumps of the CS range can be universally implemented in the food, beverage, pharmaceutical, cosmetic and chemical industries.
- They meet the highest standards in terms of quality, hygienic design, and careful product conveyance.
- The pumps can be cleaned and disinfected in a circular or flow process without having to be dismantled.

7.4.2 Observed guidelines

- seepex pumps of the CS range are certified in accordance with 3-A Sanitary Standards (USA) (model designations: BCSO, BTCS, MDC, MDTC) and designed according to the EHEDG guideline.
- In addition to AISI 300 series stainless steels, FDA-compliant non-metallic materials are also used.
- For pumps with closed joints, joint grease with a declaration of conformity in accordance with NSF-H1 is used (NSF = The Public Health and Safety Company, USA).

7.4.3 Assembly construction

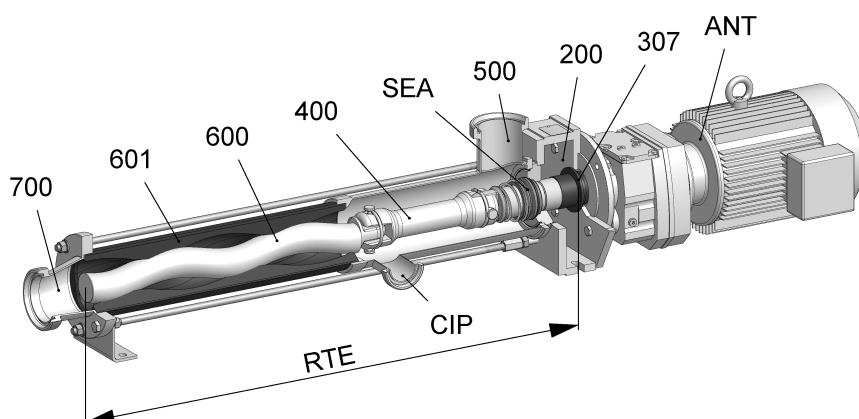

Item	Denomination	
ANT	Drive	
200	Lantern	
307	Plug-in shaft	
400	Coupling rod	
SEA	Shaft seal	
500	Suction casing	
600	Rotor	
RTE	Rotating unit	
601	Stator	
700	Pressure branch	
CIP	CIP connection	

7.4.4 Designs

7.4.4.1 BCSO, MDC ranges

- Rotating unit (RTE) with open joints.
- Certified in accordance with 3-A Sanitary Standards and designed according to EHEDG guidelines.
- Conveying capacities: BCSO 30 l/h - 130 m³/h; MDC range 0.5 l/h - 500 l/h.
- Pressures: up to 24 bar.

7.4.4.2 BSCB range

- Rotating unit (RTE) with closed pin joints.
- Conveying capacities: 30 l/h - 130 m³/h.
- Pressures: up to 24 bar.

7.4.4.3 BTCS, MDTC ranges





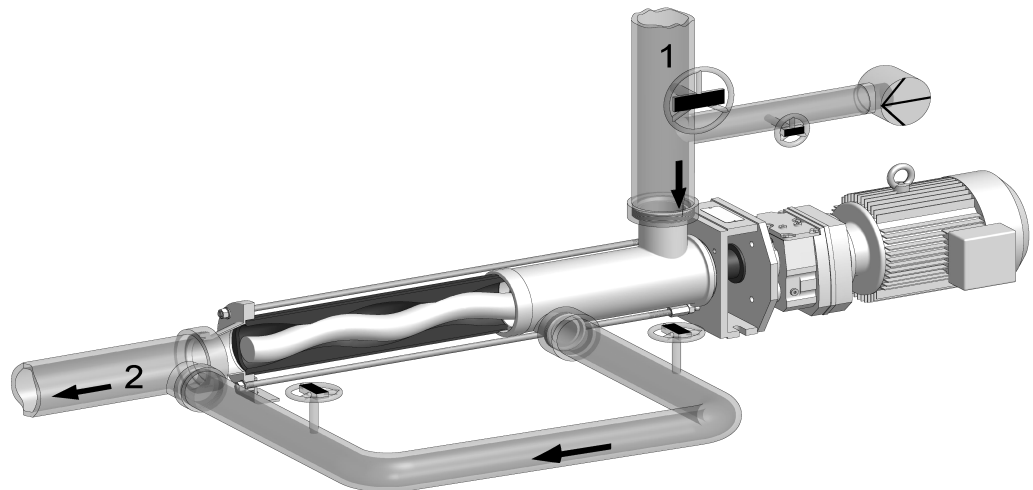

- Feed hopper pump with cylindrical/conical compression zone and a feed screw for conveying highly viscous products with low flowability.
- Rotating unit (RTE) with open joints, optionally with closed joints.
- Certified in accordance with 3-A Sanitary Standards (open joint design) and designed according to EHEDG guidelines.
- Conveying capacities: BTCS range 30 l/h - 130 m³/h; MDTC range 0.5 l/h - 500 l/h.
- Pressures: up to 24 bar.

7.4.5 Benefits and properties

- Pump housings which are almost dead space free prevent product deposits.
- High-quality surfaces of inner parts which come into contact with the product allow residue-free cleaning.
- Easy maintenance due to plug-in between rotating unit and drive.
- Mechanical seals, which are adapted to the particular application, ensure a hygienic shaft seal.
- Stator material and secondary seals with FDA approval guarantee high product safety.
- A tangentially aligned flushing connection (optional) enables extensive residual draining of the pump.
- Flushing with high flow speed within the suction casing enables residue-free cleaning.
- Disinfection can be carried out using steam, superheated steam or chemical disinfectant.

7.4.6 Cleaning processes (CIP/SIP)



- 1 Suction side
- 2 Pressure side
-  Valve closed (observe flow direction)
-  Valve opened (observe flow direction)
-  Centrifugal pump (CIP pump); customer side
-  Bypass line; customer side
-  Pipeline (suction side); customer side
-  Pipeline (pressure side); customer side

General

- Production installations in the food, beverage, pharmaceutical, cosmetic and chemical industries are often equipped with automated cleaning systems.
- CIP stands for "Cleaning in Place"
 - This means that the respective installation equipment does not have to be disassembled or dismantled for cleaning.
 - High flow speed flushing within the casing parts of the pump enables residue-free cleaning.
- SIP stands for "Sterilisation in Place"
 - Thermal or chemical disinfectants, i.e. lowering the total germ level to a very low amount without disassembling or dismantling the pump.
 - Disinfectants, hot water or steam can be used as a medium.

7.4.6.1 Cleaning recommendations for CIP

- Flush the pump thoroughly before commissioning it for the first time.
- Clean the pump so that it conforms to the required hygiene regulations.
- Perform customer installation according to the figure in chapter 7.4.6.
- Install the pump so that it can be cleaned residue-free at the application location.
- Flushing processes must be carried out at a sufficient flow speed. Recommended flow speed is at least 1.5 m/s.
- During the individual flushing processes, operate the pump for max. 5 min using a low rotation speed. Then convey the cleaning agent through the bypass line while the pump is switched off.
- Use a suitable cleaning agent.

<i>NOTICE</i>
<p>Operating the pump for a longer period (> 5 min./flushing process) during the cleaning process Damage to property can occur.</p> <ul style="list-style-type: none"> ➤ Operate the pump for max. 5 minutes using a low rotation speed. ➤ Then convey the cleaning agent through the bypass line while the pump is switched off. <ul style="list-style-type: none"> – Observe figure in chapter 7.4.6.

7.4.6.2 Recommended cleaning process

Item	Cleaning process	Cleaning agent	Remarks
1.	Preparation		Extensive draining of the pump before the cleaning process, avoid dry running
2.	Pre-flushing	Fresh water	Removal of loose, adherent dirt components
3.	Alkaline flushing	Sodium hydroxide solution max. 1.5% at 60-80°C	Removing and washing away adherent contamination
4.	Intermediate flushing	Fresh water	Flushing out cleaning agent and residual dirt
5.	Acidic flushing	Nitric acid/peracetic acid max 1% at 50-70%	Disinfection; removing, washing away adherent contamination
6.	Post-flushing	Fresh water	Flushing out residual cleaning agent

<i>NOTICE</i>
<p>Application of other cleaning agents Damage to property can occur.</p> <ul style="list-style-type: none"> ➤ Consult with seepex

7.4.6.3 Cleaning recommendations for SIP

- Clean the pump so that it conforms to the required hygiene regulations.
- Perform customer installation according to the figure in chapter 7.4.6.
- Install the pump so that it can be cleaned residue-free at the application location.
- For SIP processes with disinfectants or hot water, proceed in the same way as for CIP processes.
 - Cleaning recommendations can be found in chapter 7.4.6.1.
- For SIP processes with steam, the steam should only be conveyed through the bypass line.
 - Do not operate the pump at the same time.

Thermal disinfection

 CAUTION	
Disinfection with hot water or steam	
Minor injuries can occur. Burns due to contact with hot surfaces.	
➤ Observe appropriate protective measures.	

NOTICE	
Disinfection with steam	
Damage to property can occur.	
➤ Only convey steam through the bypass line. Do not operate the pump at the same time. <ul style="list-style-type: none">– Observe figure in chapter 7.4.6.	

Chemical disinfection

 CAUTION	
Disinfection with chemical agents	
Minor injuries can occur due to contact with cleaning agents.	
➤ Observe notes from the manufacturer.	

NOTICE	
Operating the pump for a longer period (> 5 min./flushing process) during the cleaning process	
Damage to property can occur.	
➤ Operate the pump for max. 5 minutes using a low rotation speed.	
➤ Then convey the cleaning agent through the bypass line while the pump is switched off. <ul style="list-style-type: none">– Observe figure in chapter 7.4.6.	

Refer to technical data (chapter 3.) for application range of the pump.

Malfunction								Causes	Rectification
Pump is not sucking	Pump pumping unevenly	Conveying capacity is not achieved	Pressure head is not reached	Pump does not start up	Pump seized / pump does not pump	Pump is loud when running	Motor gets too hot		
			X				X	Static friction between stator/rotor too great.	Apply lubricant (liquid soap) between stator and rotor.
X								Incorrect direction of rotation.	Check direction of rotation and swap over motor connections if necessary.
X	X	X			X	X		Suction pipe or shaft seal leaking.	Eliminate leaks.
X	X	X				X		Suction head too great.	Check the suction head, if necessary increase pipe cross section on suction pipe and use a larger filter, open suction-side valve fully.
X	X	X						Viscosity of conveying product too great.	Check/adapt (data sheet).
		X	X				X	Pump rotation speed incorrect.	Correct rotation speed (data sheet).
	X	X							Avoid air bubbles in the conveying product.
		X	X	X		X	X	Pressure head too great.	Check pressure head with pressure gauge, reduce pressure head by using larger pressure pipe crossed section or shortening the pressure pipe.
X	X	X			X		X	Pump running partially/ completely dry.	Check there is adequate conveying product available on the suction side. Dry running protection DRP.
						X	X	Check coupling.	If necessary, move pump in relation to drive, check wear on coupling gear, re-adjust coupling if necessary.
X		X						Rotation speed too low.	Increase rotation speed for low-viscosity media/large suction volume.

Malfunction									Causes	Rectification	
Pump is not sucking	Pump pumping unevenly	Conveying capacity is not achieved	Pressure head is not reached	Pump does not start up	Pump seized / pump does not pump	Pump is loud when running	Motor gets too hot	Premature stator wear			Shaft seal is leaky
X	X					X				Rotation speed too high.	Reduce rotation speed for high-viscosity media, risk of cavitation.
						X				Joint play too large.	Check mounting of coupling rod bushing.
X		X		X	X			X		Foreign objects in pump.	Dismantle pump, remove foreign bodies, replace defective parts.
X		X	X		X					Stator/rotor worn.	Dismantle pump and renew defective parts.
X		X			X	X				Joint parts worn.	Renew joint parts, use seepex pin joint grease.
X		X			X			X		Suction pipe blocked.	Clean the suction pipe.
X				X	X		X	X		Temperature of pumping liquid too high.	Check temperature, use an undersize rotor.
X		X		X			X		X	Gland packing too firm/worn.	Loosen packing gland or tighten. Renew unusable packing rings.
X				X	X			X		Solid content and/or grain size too great.	Reduce pump speed, install screen with permitted mesh width. Increase liquid proportion.
X				X				X	X	Sedimentation/gumming of solids when pump stationary.	Rinse through and clean the pump immediately.
X				X	X			X	X	Conveying product hardens when the temperature drops below a certain limit.	Heat the pump.
				X	X		X	X		Stator swollen and unable to withstand conveying product.	Select a suitable stator material, use an undersize rotor.
						X			X	Bearings in pump drive housing or drive unit defective.	Renew bearings.
									X	Mechanical seal defective.	Check sliprings and O-rings for wear/resistance, renew if necessary.

9. Dismantling/Reassembly of the pump

9.1 Prepare pump for dismantling

DANGER



Risk of fatal injury from electrical current.

There is an immediate danger of fatal electric shock through contact with live parts.

- Note safety regulations.
- Disconnect motor from all sources of energy.
- Secure electrical connections against restarting.

- Empty pipelines.
- Allow pipelines to cool.
- Remove pipeline connections (suction side/pressure side).
- Observe de-commissioning instructions (→ chapter 6).

9.1.1 Dismantle pump

⚠ WARNING Risk of injury due to lack of stability of pump. Crushing of body parts due to the pump or pump parts tipping or falling down.

Design with base plate

- Fasten base plate (**GPU**) to secure pump.
 - Recommendation: Fasten to suitable base using a screw fitting (**SCH**).

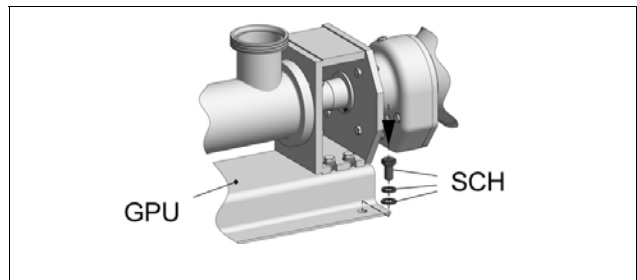

Design without base plate

- Fasten lantern (**200**) to secure the pump.
 - Recommendation: Fasten to suitable base using a screw fitting (**SCH**).

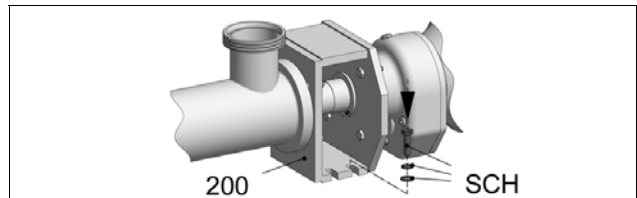

9.1.2 Dismantle pressure branch (700)

- Support stator (**601**) with support (**S**).
- Dismantle screw fitting (**604, 606, 609**).
- Remove pressure branch (**700**), trestles (**607, 704**) and tie bolts (**602**).

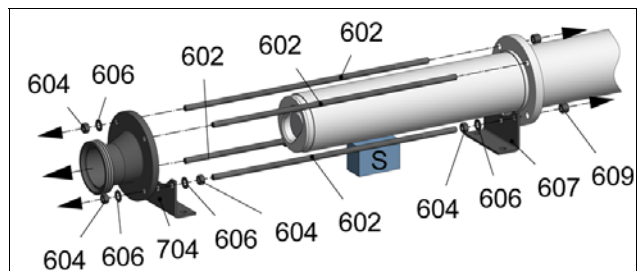

9. Dismantling/Reassembly of the pump

9.1.3 Dismantle stator (601)

- Raise/reposition (310) splash ring to remove (309) plug-in shaft pins.
- Eject (309) plug-in shaft pins.
 - Use a suitable tool (WS).
- Turn tool (WS) upwards as locking device for the stator removal.

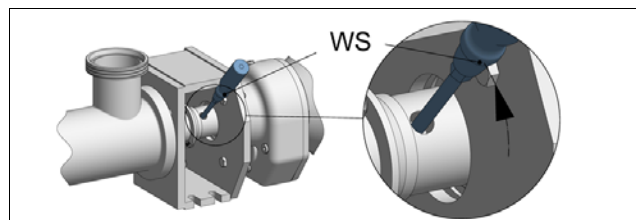
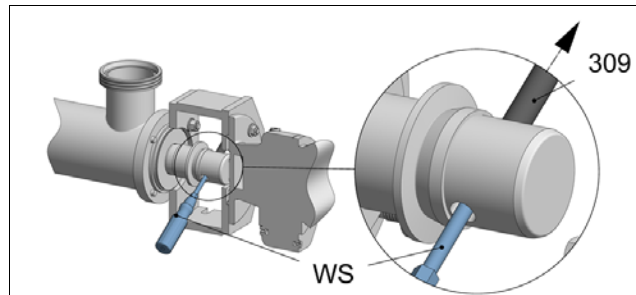
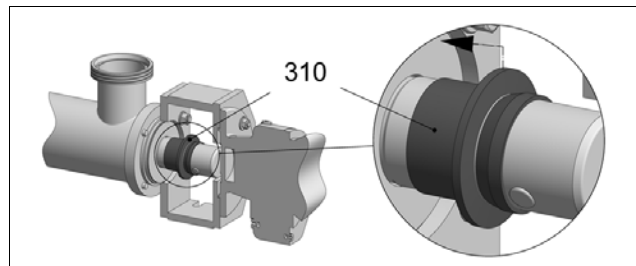

Dismantle dry-running protection device (TSE) (optional)

NOTICE Damage to pump sided parts of the dry-running protection device (TSE) during dismantling the stator.

- Before dismantling the stator, remove all pump sided parts of the dry-running protection device (TSE).
 - Note chapter options and accessories (→ chapter 12.1).
- Turn stator (601) to remove it.
 - Apply lubricant (GM) into the opening between rotor (600) and stator (601) for easier dismantling.
 - Use tool (W2).
- Support rotor (600) with support (S).

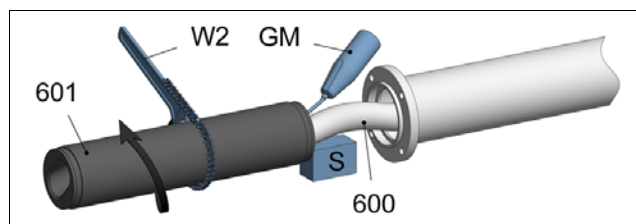

9.1.4 Dismantle suction casing (500)

- Put a protective cover (SH) on the rotor (600).
- Prop up rotor (600) with support (S).
- Dismantle screw fitting (508, 509).
- Remove suction casing (500) and casing gasket (501).
- Remove tool (WS).

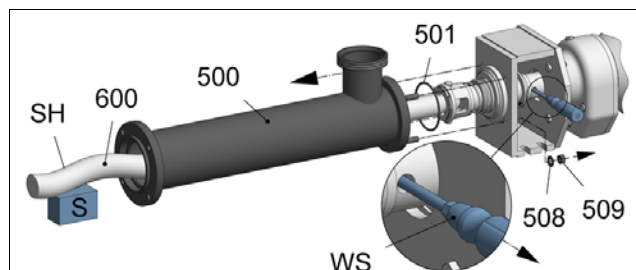

9. Dismantling/Reassembly of the pump

9.1.5 Dismantle rotating unit (RTE)

-  Assemble tool (**W10**) as contact surface for mounting lever (**W9**).

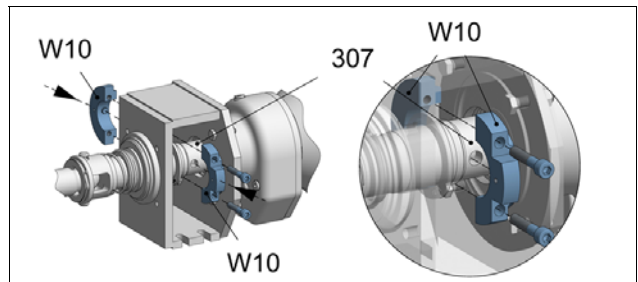

- Pull off rotating unit (**RTE**) with shaft seal (**SEA**) from output shaft of drive (**ANT**).
 -  Use tool (**W9**).

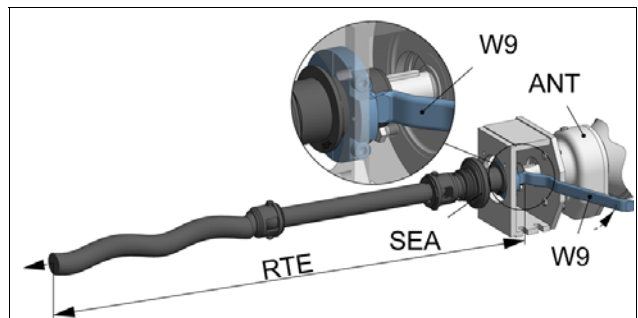

-  Dismantle tool (**W10**).

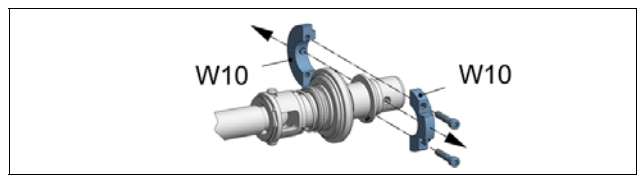

- Remove splash ring (**310**) and shaft seal casing (**SEA**) from plug-in shaft (**307**).
 - Observe shaft sealing dismantling instructions (→ chapter 9.4).

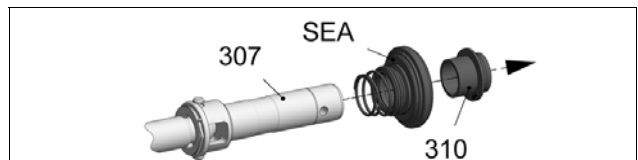

9.1.6 Dismantle rotor (600), coupling rod (400) and plug-in shaft (307)

- Joint (**G**) dismantling note rotating unit - individual parts (→ chapter 9.2).

9.1.7 Dismantle drive (ANT)

- Dismantle screw fitting (**210**, **212**, **213**).
- Remove drive (**ANT**).

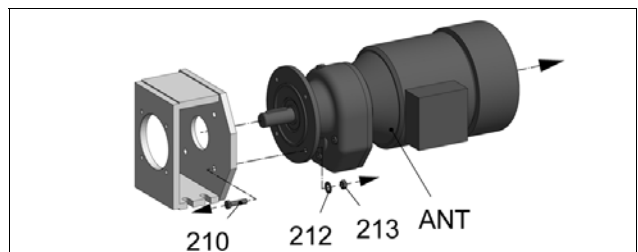

9. Dismantling/Reassembly of the pump

9.1.3 Assemble pump

⚠ WARNING Risk of injury due to lack of stability of pump. Crushing of body parts due to the pump or pump parts tipping or falling down.

Design with base plate

- Fasten base plate (**GPU**) to secure pump.
 - Recommendation: Fasten to suitable base using a screw fitting (**SCH**).

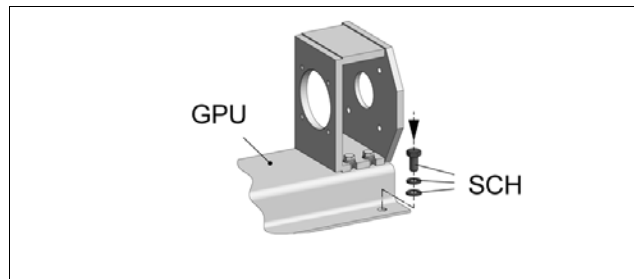

Design without base plate

- Fasten lantern (**200**) to secure the pump.
 - Recommendation: Fasten to suitable base using a screw fitting (**SCH**).

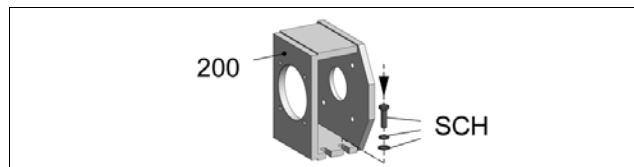

9.1.3.1 Assemble drive (ANT)

- Clean flange bearing surfaces (**FLS**), centering surface (**ZD**) and output shaft of the drive (**ANT**).
- Assemble drive (**ANT**) with screw fitting (**210**, **212**, **213**) on lantern (**200**).

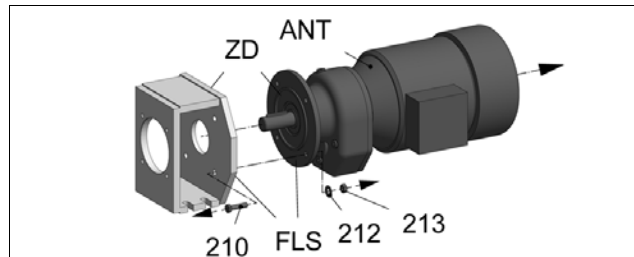

9.1.3.2 Assemble rotor (600), coupling rod (400) and plug-in shaft (307)

- Joint (**G**) reassembly note rotating unit - individual parts (→ chapter 9.2).

9.1.3.3 Assemble rotating unit (RTE)

- Slide shaft seal casing (**SEA**) onto plug-in shaft (**307**).
 - Observe instructions for shaft seal reassembly (→ chapter 9.4).

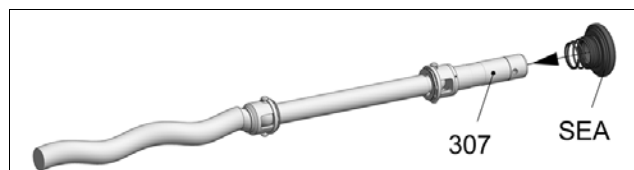

- Coat inner surface of splash ring (**310**) and outer surface of plug-in shaft (**307**) with anti-seize graphite petroleum (**GC**) for easier assembly of the splash ring (**310**).
- Slide splash ring (**310**) onto plug-in shaft (**307**).
 - Observe fitting position of splash ring (**E**) (lettering „SEA“).

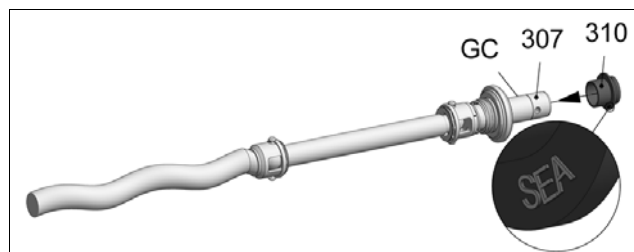

9. Dismantling/Reassembly of the pump

- Moisten output shaft of drive (**ANT**) with anti-seize graphite petroleum (**GC**) for easier assembly.
- Push rotating unit (**RTE**) onto output shaft of the drive (**ANT**).

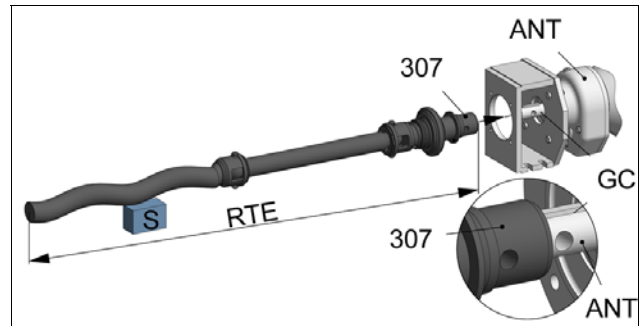

9.1.3.4 Assemble suction casing (500)

- Fit rotor (**600**) with protective cover (**SH**).
- Prop up rotor (**600**) with support (**S**).
- Push casing gasket (**501**) onto the shaft seal casing (**SEA**).
- Assemble and align suction casing (**500**) with screw fitting (**508, 509**).
 - Use spirit level (**WW**).
- Tighten screw fitting (**508, 509**).
- Remove protective cover (**SH**) from rotor (**600**).

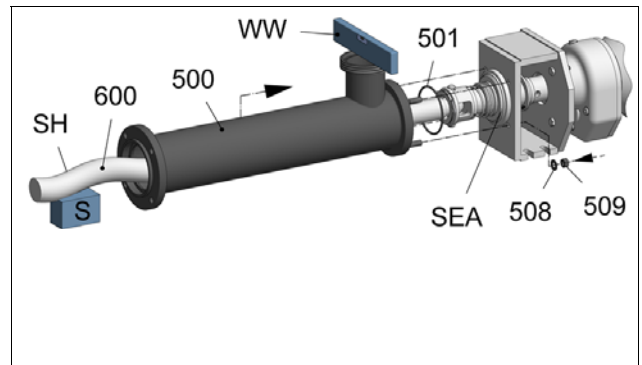

9.1.3.5 Assemble stator (601)

- Insert tool (**WS**) and turn downwards as locking device for stator assembly.
- For easier assembly of the stator (**601**), moisten outer surface of rotor (**600**) and inner surface of stator (**601**) with lubricant (**GM**).
- Support stator (**601**) with a support (**S**).
 - Push support (**S**) of suction casing (**500**) under stator (**601**).
- Slide the stator (**601**) onto the rotor (**600**) by turning it.
 - Use tool (**W2**).

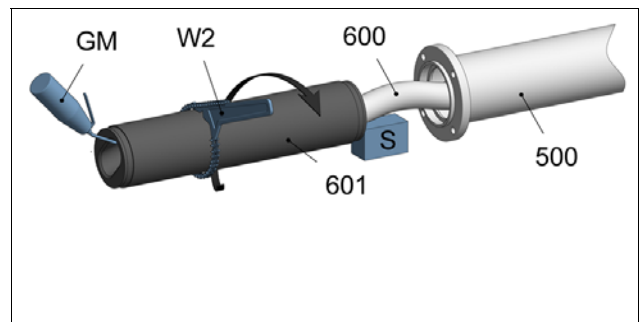
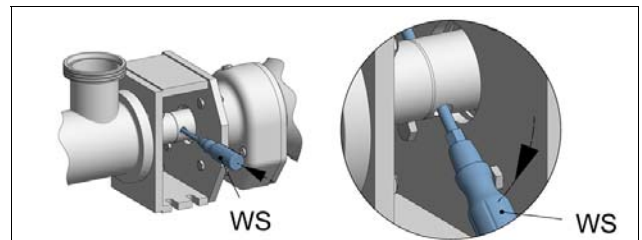

9. Dismantling/Reassembly of the pump

- Remove tool (**WS**).
- Coat the plug-in shaft pins (**309**) with anti-seize graphite petroleum (**GC**) and insert in plug-in shaft (**307**).

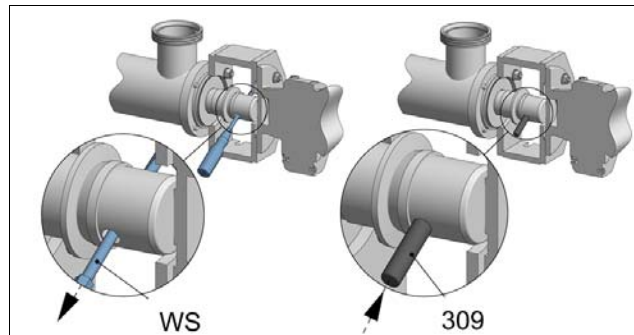

- Note position of splash ring (**310**).
- Insert splash ring collar at a distance of 0.5 mm from the lantern (**200**).

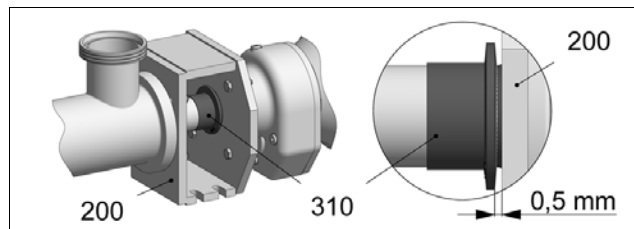

Assemble dry-running protection device (TSE) (optional)

- Observe the chapter Options and additional accessories (→ chapter 12.1).

9.1.3.6 Assemble pressure branch (700)

- Insert tie bolts (**602**) together with trestle (**607**, **704**) and screw fitting (**604**, **606**) into suction casing (**500**).

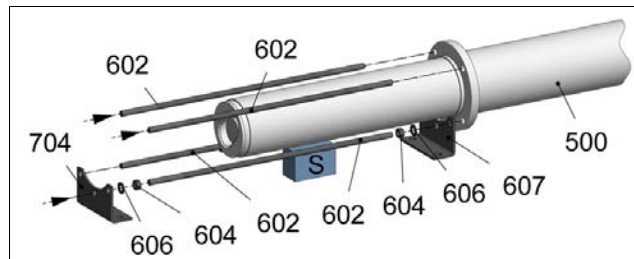

- Push pressure branch (**700**) onto the stator (**601**).
- Insert tie bolts (**602**) loosely in the pressure branch (**700**).
- Remove the support (**S**).

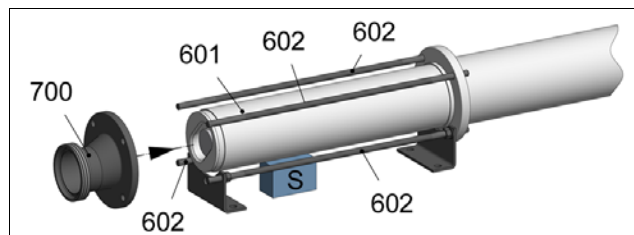

- Assemble screw fitting (**604**, **606**, **609**).
- Tighten tie bolts (**602**) evenly.

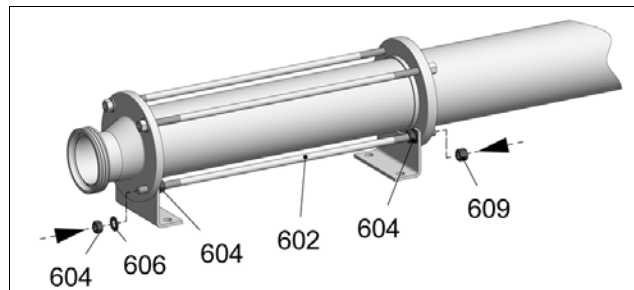

9. Dismantling/reassembly

9.2 Rotating Unit - Individual Parts

9.2.1 Dismantle rotating unit (RTE)

9.2.1.1 Separate joint - on rotor side

- Press circlip (401) out of groove.
- Slide support ring (491) onto coupling rod (400).

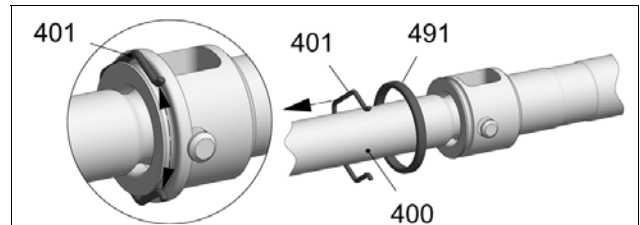

- Kuppelstangenbolzen (402) ausstoßen.
- Rotor (600) entfernen.

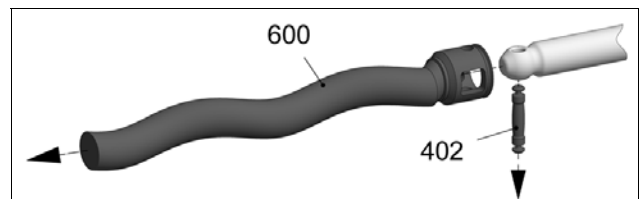

9.2.1.2 Separate joint - on drive side

- Press circlip (401) out of groove.
- Slide support ring (491) onto coupling rod (400).

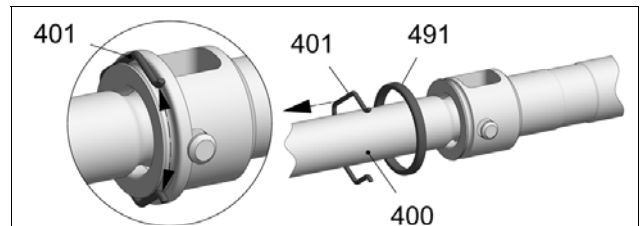

- Kuppelstangenbolzen (402) ausstoßen.
- Kuppelstange (400) entfernen.

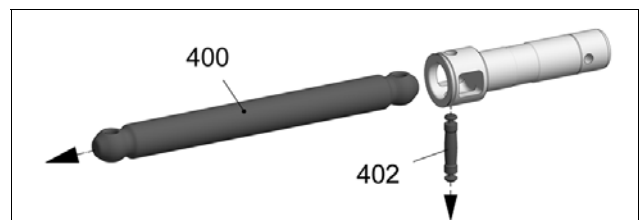

9.2.1.3 Rotating unit (RTE) – preparing component parts for assembly

Prepare rotor (600) for assembly

- Remove any damage.
- Clean rotor (600).

Prepare coupling rod (400) for assembly

- Clean coupling rod (400).
- In the event of wear/damage, replace coupling rod (400).

Prepare plug-in shaft (307) for assembly

- Remove any damage.
- Clean plug-in shaft (307).

9. Dismantling/reassembly

Prepare circlip (401) and support ring (491) for assembly

NOTICE Malfunction of the joints. Malfunction and/or destruction of the joints.

- Check circlip (401) and support ring (491) for damages and deformation.
 - Renew coupling rod pin (402) and circlip (401) and support ring (491) together.

9.2.2 Assemble rotating unit (RTE)

9.2.2.1 Connect coupling rod (400) and plug-in shaft (307)

- Slide support ring (491) onto coupling rod (400).

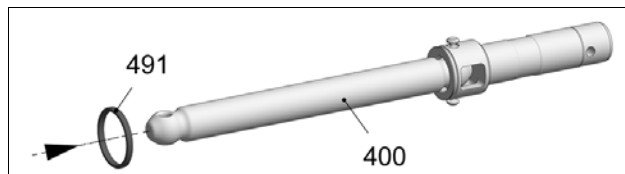

- Insert coupling rod (400) into plug-in shaft (307).
- Insert coupling rod pin (402).

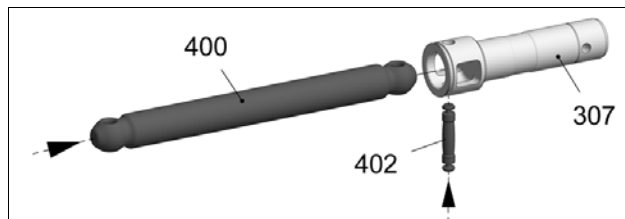

- Push support ring (491) to the coupling rod pin (402).

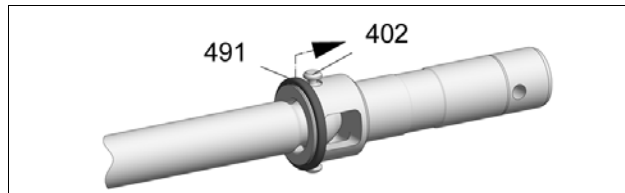

- Push circlip (401) into groove of the plug-in shaft (307).
 - Ensure a correct fit of the circlip (401).

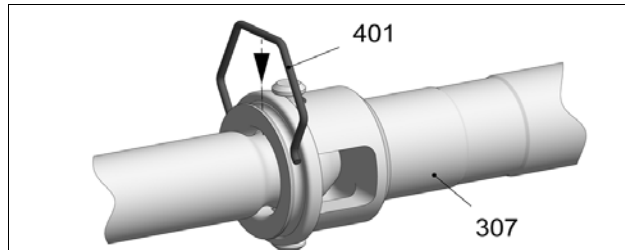

9.2.2.2 Rotor (600) and coupling rod (400)

- Slide closed circlip (491) onto coupling rod (400).

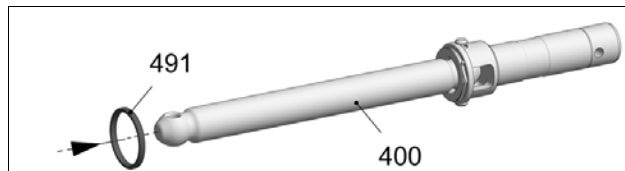

- Slide rotor (600) onto coupling rod (400).
- Insert coupling rod pin (402).

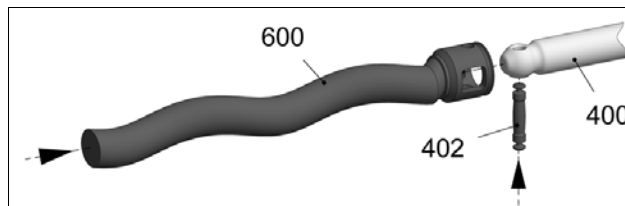

9. Dismantling/reassembly

- Push support ring **(491)** to the coupling rod pin **(402)**.

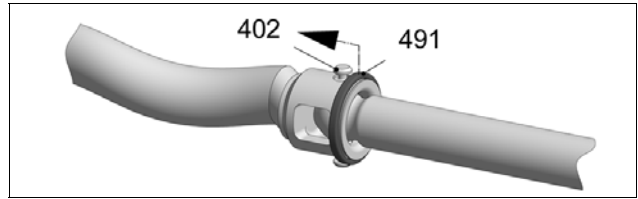

- Push circlip **(401)** into groove of the rotor **(600)**.
 - Ensure a correct fit of the circlip **(401)**.

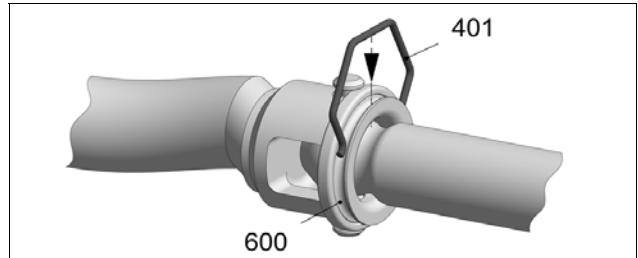

9.4 / 9.5 Shaft sealing

9.4.1 Safety

 WARNING	
Shaft seal is leaky. Leakage may escape into the atmosphere.	
<ul style="list-style-type: none">➤ Take safety measures to protect persons and the environment.➤ Wear suitable protective clothing.➤ Dispose of leakage appropriately.➤ Note applicable regulations when handling hazardous substances.	

9.4.2 Operating conditions and material combination

- Adjust to the relevant application
 - Design variants you will find at <http://www.seepex.com/en/service/downloads/>.

10.1 Spare parts list

10.2 Sectional drawing and parts list

10.1 Ordering spare parts

Commission number

The commission number and type are printed on the type plate of your SEEPEX machine.

Type

Request

After placing the order, you will receive an order confirmation and deadline before the parts are shipped.

Order

Your data

First Name

Surname

Company

Department

Street

Postcode, City

Telephone

Fax

E-mail

Our contact data

Customer Service
Fax +49.2041.996-5350
service@seepex.com

10. Order

Order spare parts or complete packages tailored to your pump type.

Spare parts

Plug-in shaft and shaft seal

No.	Component	Qty.
307	Plug-in shaft	<input type="checkbox"/>
309	Plug-in shaft pin	<input type="checkbox"/>
310	Splash ring	<input type="checkbox"/>
330	Mechanical seal	<input type="checkbox"/>

Coupling rod and joint parts

No.	Component	Qty.
400	Coupling rod	<input type="checkbox"/>
401	Circlip	<input type="checkbox"/>
402	Coupling rod pin	<input type="checkbox"/>
491	Closed circlip	<input type="checkbox"/>

Pumping elements

No.	Component	Qty.
600	Rotor	<input type="checkbox"/>
601	Stator	<input type="checkbox"/>

Miscellaneous parts

No.	Component	Qty.
501	O-ring	<input type="checkbox"/>

Complete packages

small wearing parts package

consisting of:	Qty.
1 x Clirclip (401)	<input type="checkbox"/>
1 x Coupling rod pin (402)	
1 x Closed circlip (491)	
1 x Casing gasket (501)	
1 x Rotor (600)	
1 x Stator (601)	

large wearing parts package

consisting of:	Qty.
1 x Plug-in shaft (307)	<input type="checkbox"/>
1 x Splash ring (310)	
1 x Mechanical seal (330)	
1 x Coupling rod (400)	
2 x Clirclip (401)	
2 x Coupling rod pin (402)	
2 x Closed circlip (491)	
1 x Casing gasket (501)	
1 x Rotor (600)	
1 x Stator (601)	

Place, date

Signature, company stamp

Version for copying

Spare parts can be ordered online or requested from
www.seepex.com

Must be specified with every order!

Commission: _____

Mark tool!

Sender:



Contact:

Tel.:

Fax:

E-mail:

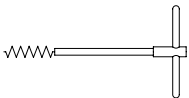
Customer service: seepex GmbH Postfach 10 15 64 D-46215 Bottrop service@seepex.com	Germany	Tel +492041.996-231 Fax +492041.996-431	Delivery address:
	Rest of Europe	Tel +492041.996-224 Fax +492041.996-424	
	outside Europe	Tel +492041.996-120 Fax +492041.996-432	

For installation of:	Packing gland	Stator		
Tool no.	W1 <input type="checkbox"/>	W2 <input type="checkbox"/>	<input type="checkbox"/>	<input type="checkbox"/>
Denomination:	Packing puller	Chain wrench plus spare chain		
Order no.	PKZ	KRZ		
				

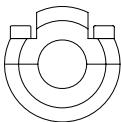
For installation of:	Plug-in shaft	Rotating unit		
Tool no.	W10 <input type="checkbox"/>	<input type="checkbox"/>	<input type="checkbox"/>	<input type="checkbox"/>
Denomination:	Dismantling tool			
Order no.	AZV			
				

12.1 Accessories/Technical information

- Accessories and technical information are commission specific documents not part of this not binding operating and assembly instruction.

13.1 Manufacturer's and supplier's documents

- Manufacturer's and supplier's documents are commission specific documents and not part of this not binding operating and assembly instruction.

Great Britain

SEEPEX UK Ltd.
3 Armtech Row
Houndstone Business Park
Yeovil Somerset BA22 8RW
Tel +44.1935.472376
Fax +44.1935.479836
sales@seepex.co.uk

Austria

SEEPEX GmbH
Vertriebsbüro Österreich
Obermüllergasse 18
3003 Gablitz
Tel +43.2231.61085
Fax +43.2231.6108520
hfriedl@seepex.com

Belgium

SEEPEX GmbH
Bureau België
Industriezone Klein Gent-Link 21
Welvaartstraat 14-1 bus 15
2200 Herentals
Tel +32.14.501471
Fax +32.14.501461
seepex.be@seepex.com

Denmark

SEEPEX Nordic A/S
Krakasvej 7C
3400 Hillerød
Tel +45.49.192200
Fax + 45.49.193200
info.nordic@seepex.com

France

SEEPEX France SARL
1, Rue Pelloutier
77183 Croissy Beaubourg
Tel +33.1.64114450
Fax + 33.1.64114489
info.fr@seepex.com

Hungary

SEEPEX GmbH
Magyarországi iroda
Hecskó Tamás okl.vill.mérn.
Éva utca 5.
7632 Pécs
Tel +36.205806134
Fax +36.72952587
thecsko@seepex.com

Ireland

SEEPEX UK Ltd.
Branch Office Ireland
29 Lackenfune
Dungarvan
Co. Waterford
Tel +353.860450439
sales@seepex.co.uk

Italy

SEEPEX Italia S.r.l.
Via Alberto da Giussano 23
20145 Milano (MI)
Tel +39.02.36569360
Fax +39.02.92877855
info.it@seepex.com

Poland

SEEPEX GmbH
Przedstawicielstwo w Polsce
ul. Romana Maya 1
61-371 Poznan
Tel +48.61.6469270
Fax +48.61.6469271
info.pl@seepex.com

Sweden

SEEPEX Nordic A/S
Hamndalsvägen 58
61633 Åby
Tel +46.1166940
Fax +46.1166941
info.nordic@seepex.com

Spain

SEEPEX GmbH
Oficina de Representación en España
C/Copenhagen, 12
Edif. Tifan Oficina 207
28232 La Rozas
Madrid
Tel +34.91.6361353
Fax +34.91.6409371
info.es@seepex.com

The Netherlands

SEEPEX GmbH
Bureau Nederland
Visbystraat 13
7418 BE Deventer
Tel +31.570.516644
Fax +31.570.516077
seepex.nl@seepex.com

Russia

SEEPEX Ltd. Ugreshskaya
Str. 2 Bldg. 23
115088 Moscow
Tel +7.495.2874830
Fax +7.495.2874830
info.cis@seepex.com

USA

SEEPEX Inc.
511 Speedway Drive
Enon
Ohio 45323
Tel +1.937.8647150
Fax + 1.937.8647157
sales.us@seepex.com

China

SEEPEX Pumps (Shanghai) Co., Ltd.
Xuanzhong Rd. 399, Building 13
Nanhui Industrial Area
201300 Shanghai
Tel +86.21.38108888
Fax +86.21.38108899
info.cn@seepex.com

India

SEEPEX India Pvt. Ltd.
Office No. 305.
Raheja Arcade Building
Sector 11, C.B.D. Belapur
Navi Mumbai 400614
Tel +91.22.40240434/35
Fax +91.22.40240436
info.ind@seepex.com

Japan

日本シーベックス株式会社
German Industry Park
1-18-2 Hakusan, Midori-ku
Yokohama 226-0006
Tel +81.46.2595931
Fax +81.46.2595941
info.jp@seepex.com

Malaysia

SEEPEX (M) Sdn. Bhd.
No. 2, Jalan 51/203A
Kaw. Perindustrian Tiong
Nam Seksyen 51
46050 Petaling Jaya Selangor
Darul Ehsan
Tel +60.3.88009988
seepex.m@seepex.com

Australia

SEEPEX Australia Pty. Ltd.
Unit 3, 4 Bounty Close
Tuggerah Business Park
NSW 2259
Tel +61.2.43554500
Fax +61.2.43554022
info.au@seepex.com