

ZP1 Series Positive Displacement Pumps

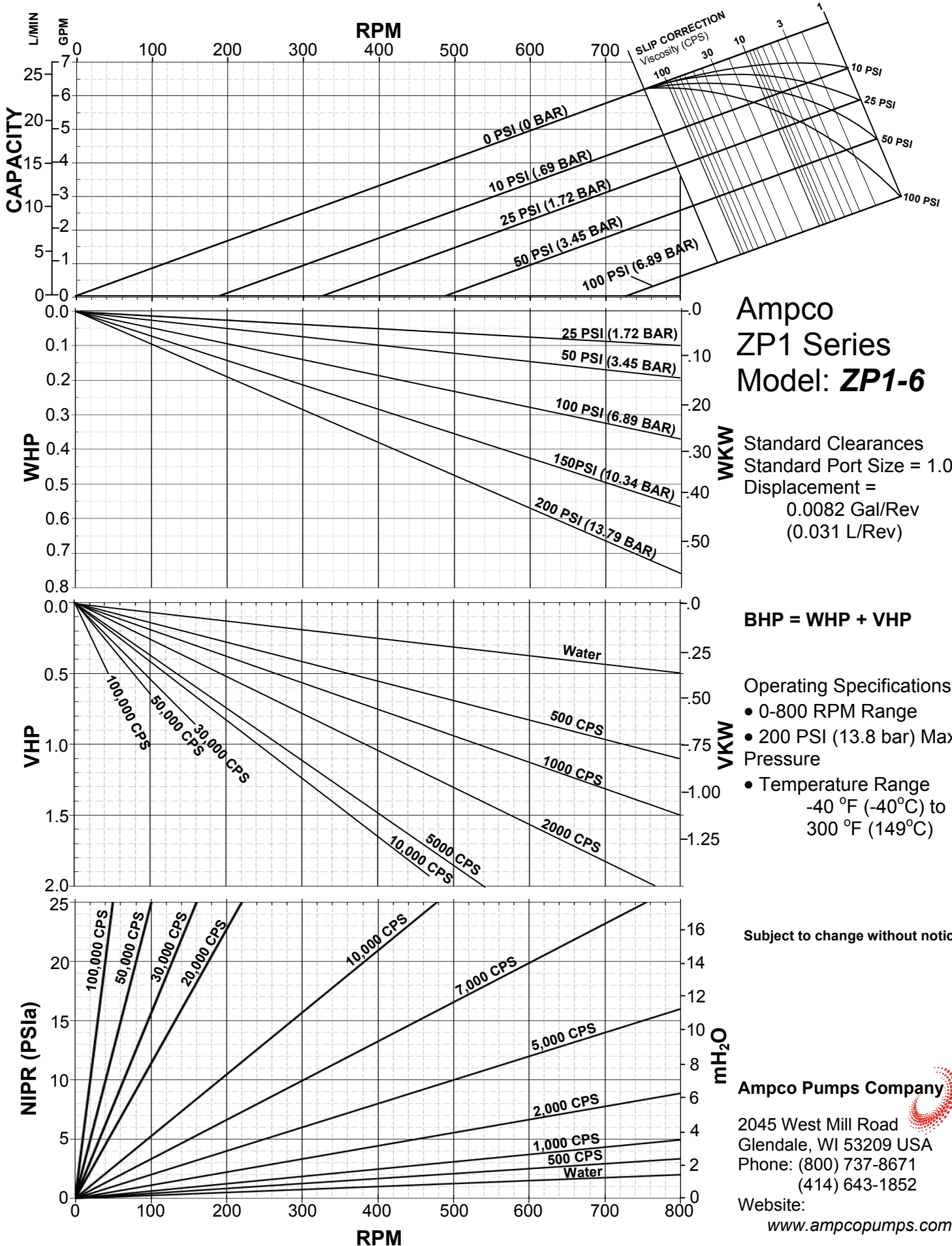

Ampco ZP1 Series Model: **ZP1-6**

Standard Clearances
Standard Port Size = 1.0"
Displacement =
0.0082 Gal/Rev
(0.031 L/Rev)

BHP = WHP + VHP

- Operating Specifications:
- 0-800 RPM Range
 - 200 PSI (13.8 bar) Max. Pressure
 - Temperature Range
-40 °F (-40°C) to
300 °F (149°C)

Subject to change without notice

Ampco Pumps Company

2045 West Mill Road
Glendale, WI 53209 USA
Phone: (800) 737-8671
(414) 643-1852

Website:
www.ampcopumps.com

ZP1 Series Positive Displacement Pumps

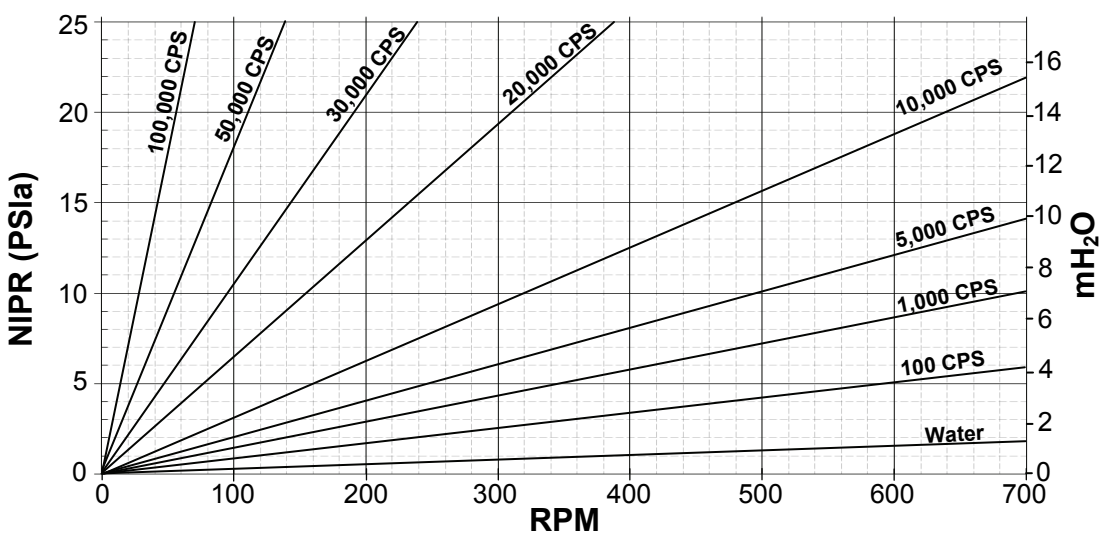
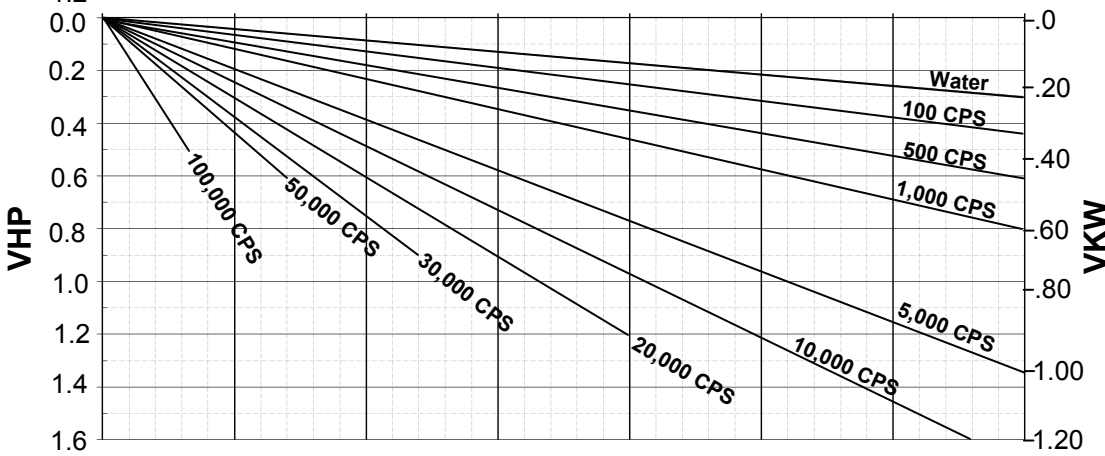
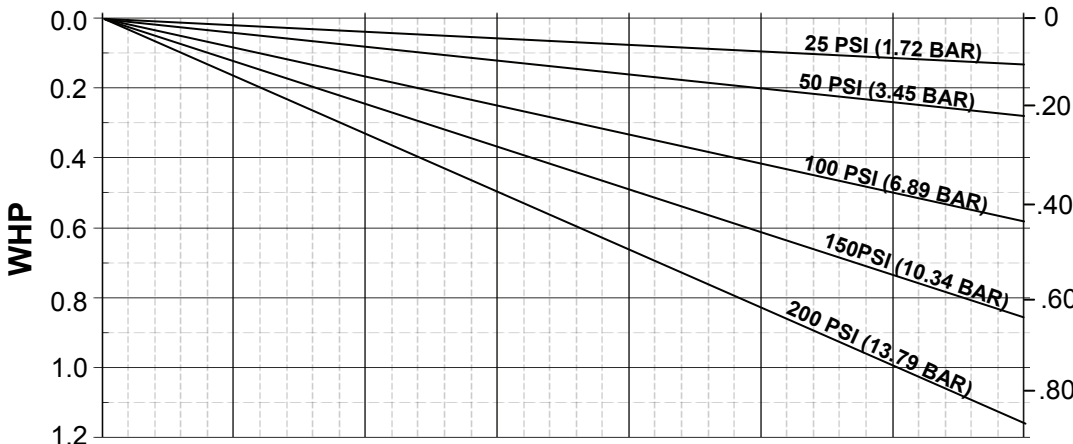
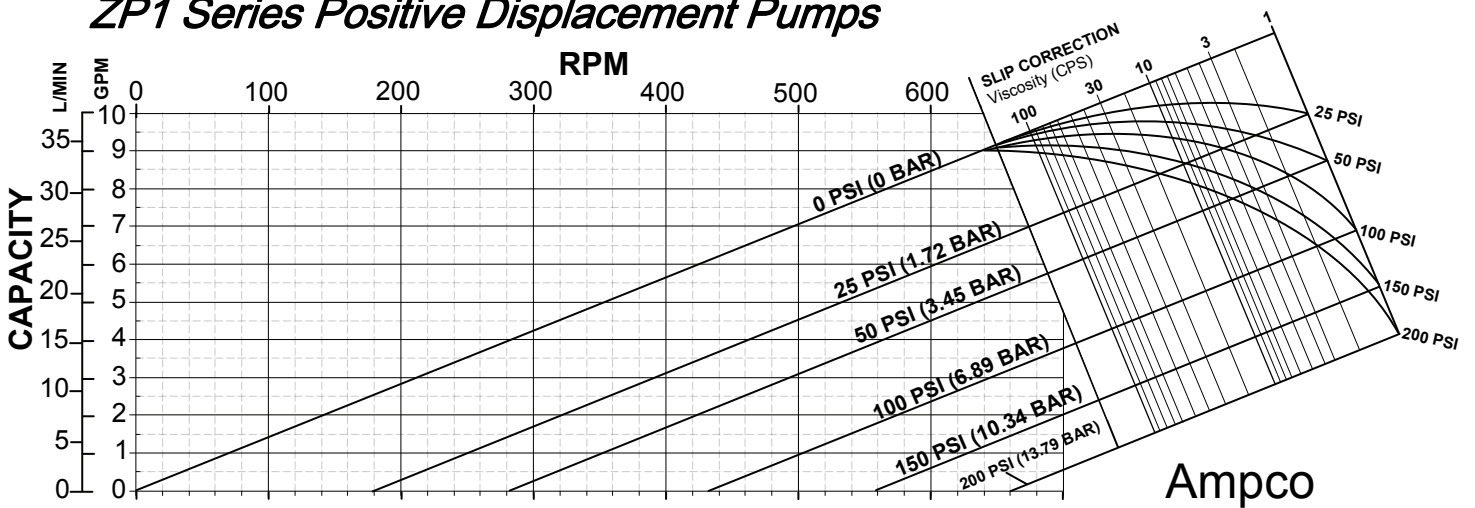

Ampco ZP1 Series Model: **ZP1-15**

Standard Clearances
Standard Port Size = 1.5"
Displacement =
0.014 Gal/Rev
(0.054 L/Rev)

BHP = WHP + VHP

- Operating Specifications:
- 0-700 RPM Range
 - 200 PSI (13.8 bar) Max. Pressure
 - Temperature Range
-40 °F (-40°C) to
300 °F (149°C)

Subject to change without notice

Ampco Pumps Company

2045 West Mill Road
Glendale, WI 53209 USA
Phone: (800) 737-8671
(414) 643-1852

Website:
www.ampcopumps.com

ZP1 Series Positive Displacement Pumps

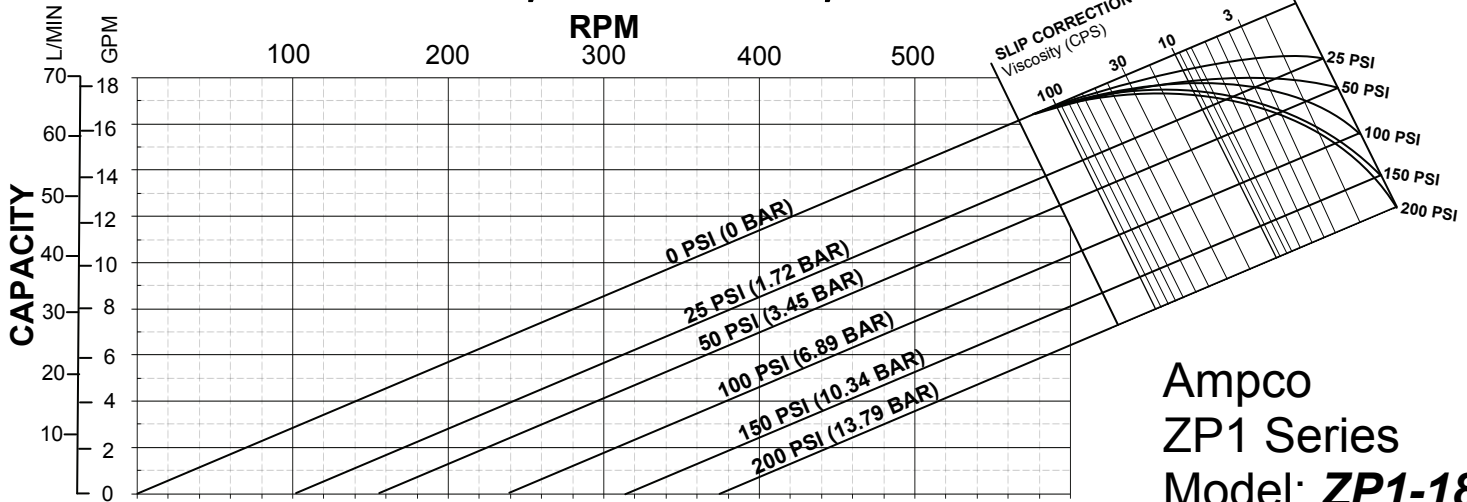

Ampco ZP1 Series Model: **ZP1-18**

Standard Clearances
Standard Port Size = 1.5"
Displacement =
0.029 Gal/Rev
(0.108 L/Rev)

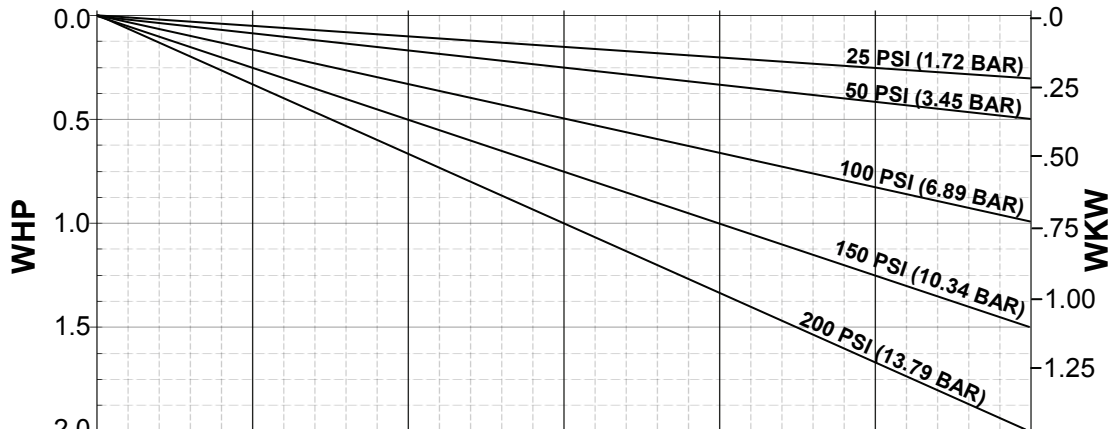

BHP = WHP + VHP

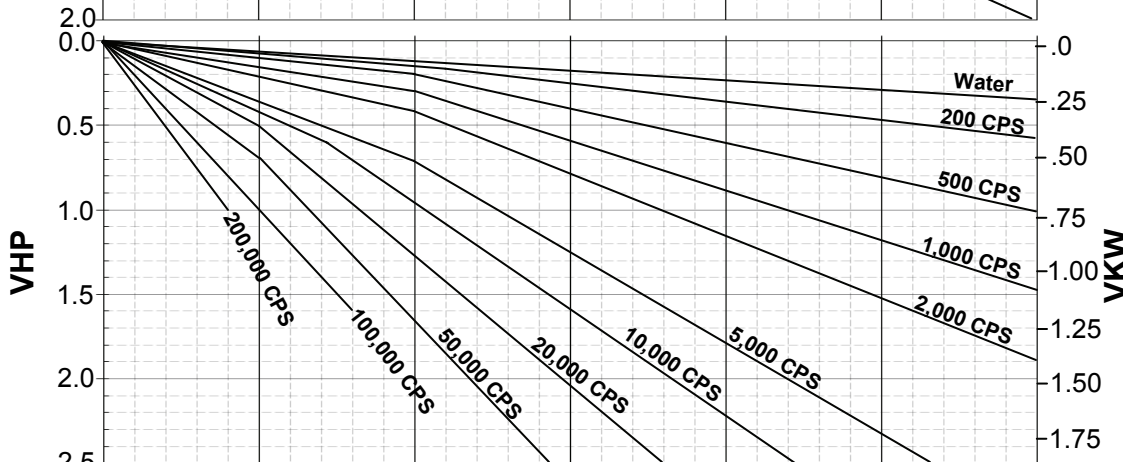

Operating Specifications:
 • 0-600 RPM Range
 • 200 PSI (13.8 bar) Max. Pressure
 • Temperature Range
 -40 °F (-40°C) to
 300 °F (149°C)

Subject to change without notice

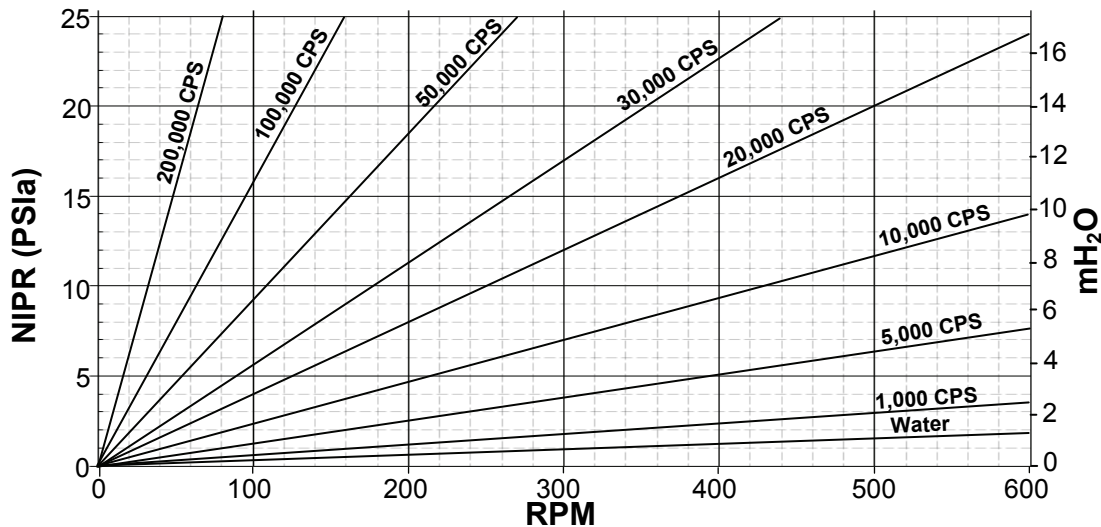

Ampco Pumps Company

2045 West Mill Road
Glendale, WI 53209 USA
Phone: (800) 737-8671
(414) 643-1852

Website:
www.ampcopumps.com

ZP1 Series Positive Displacement Pumps

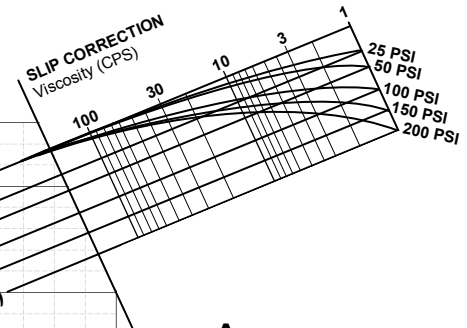
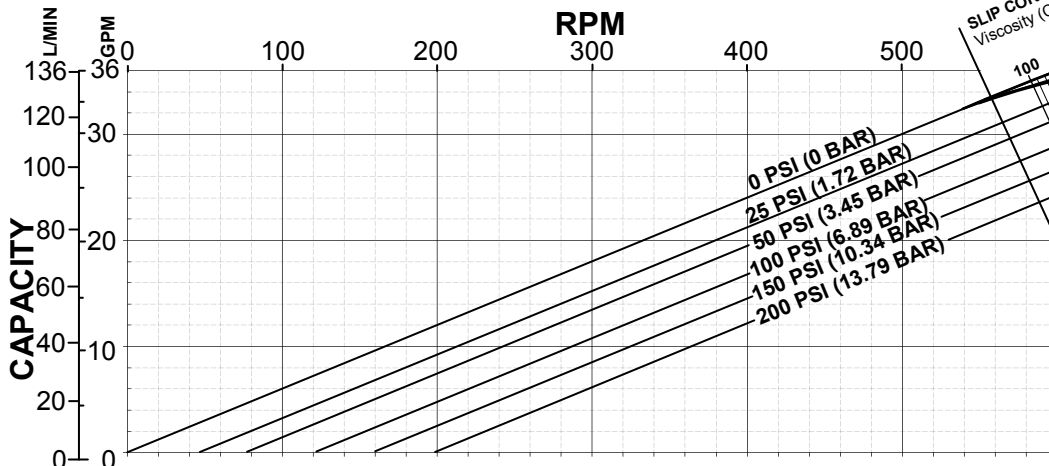

Ampco
ZP1 Series
Model: ZP1-30
ZP1-34

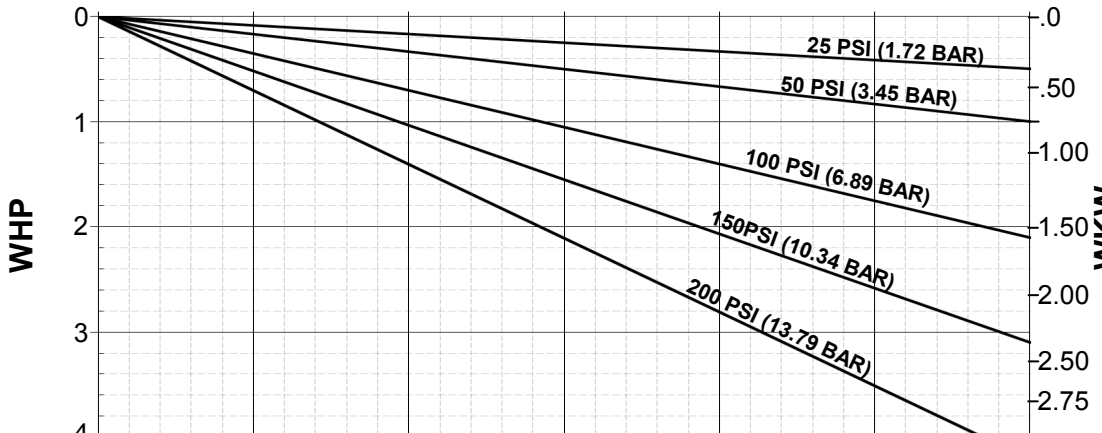

Standard Clearances
 Standard Port Size = 1.5"
 Displacement =
 0.060 Gal/Rev
 (0.227 L/Rev)

BHP = WHP + VHP

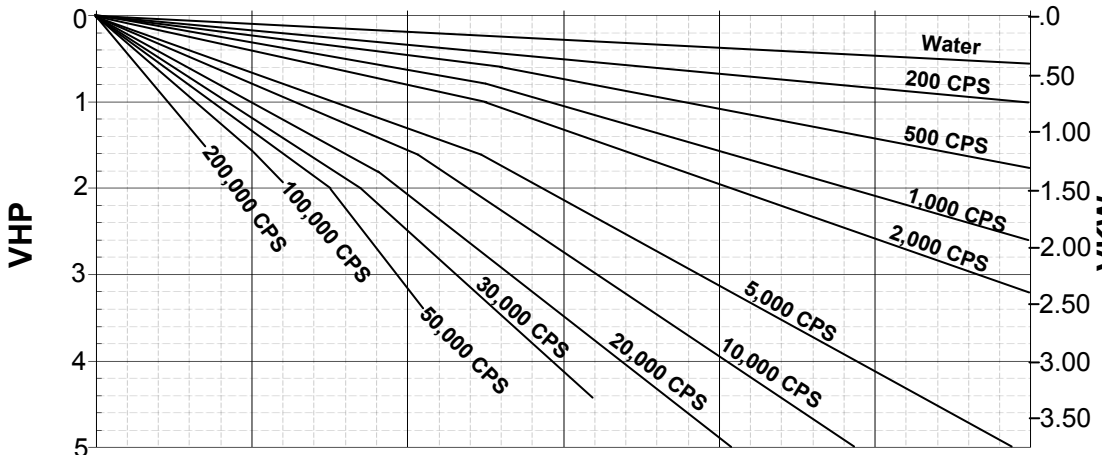

Operating Specifications:
 • 0-600 RPM Range
 • 200 PSI (13.8 bar) Max. Pressure
 • Temperature Range
 -40 °F (-40°C) to
 300 °F (149°C)

Subject to change without notice

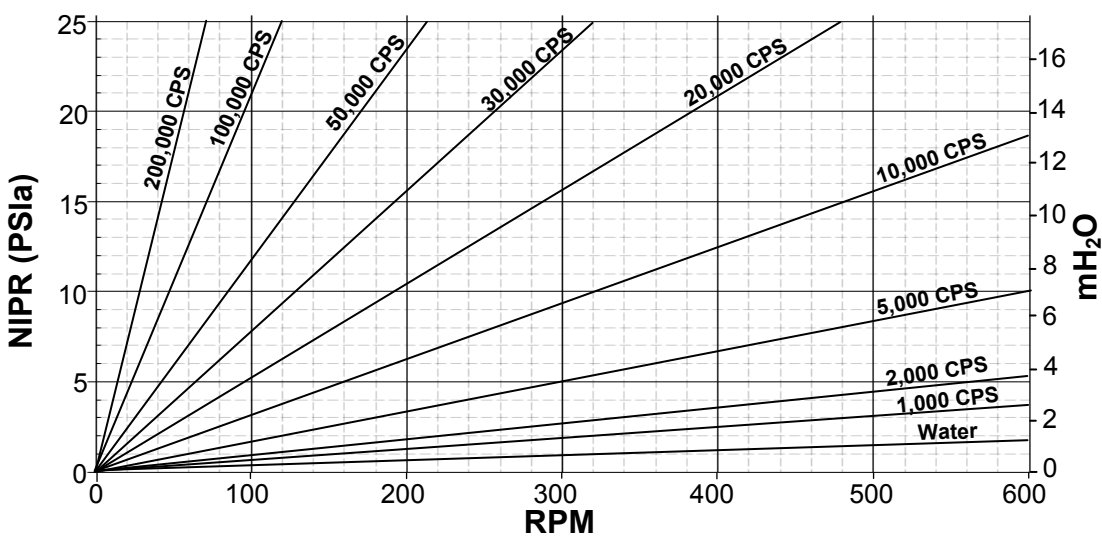

Ampco Pumps Company

2045 West Mill Road
 Glendale, WI 53209 USA
 Phone: (800) 737-8671
 (414) 643-1852

Website:
www.ampcopumps.com

ZP Series Positive Displacement Pumps

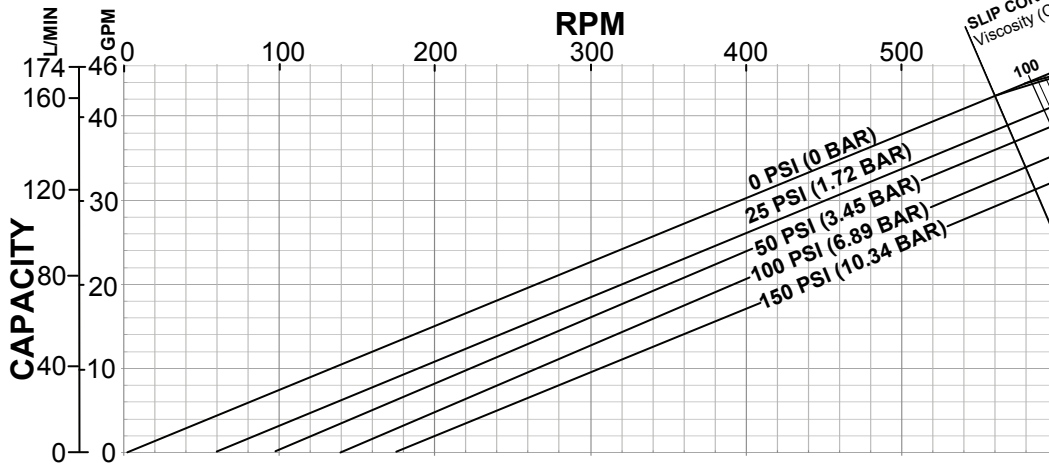

Ampco ZP Series Model: ZP1-40 / ZP2-40

Standard Clearances
 Standard Port Size = 2.0"
 Displacement =
 0.076 Gal/Rev
 (0.288 L/Rev)

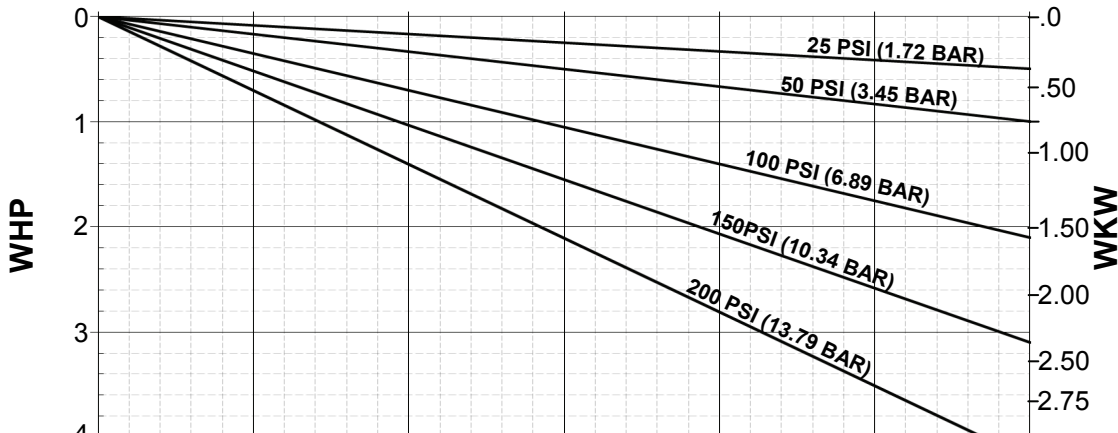

BHP = WHP + VHP

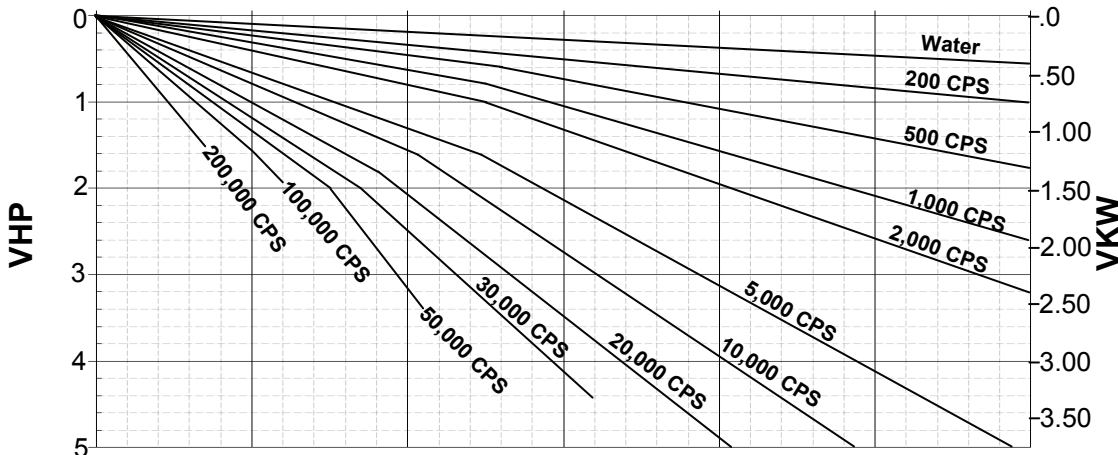

- Operating Specifications:
- 0-600 RPM Range
 - 150 PSI (10.3 bar) Max. Pressure
 - Temperature Range
 -40 °F (-40°C) to
 300 °F (149°C)

Subject to change without notice

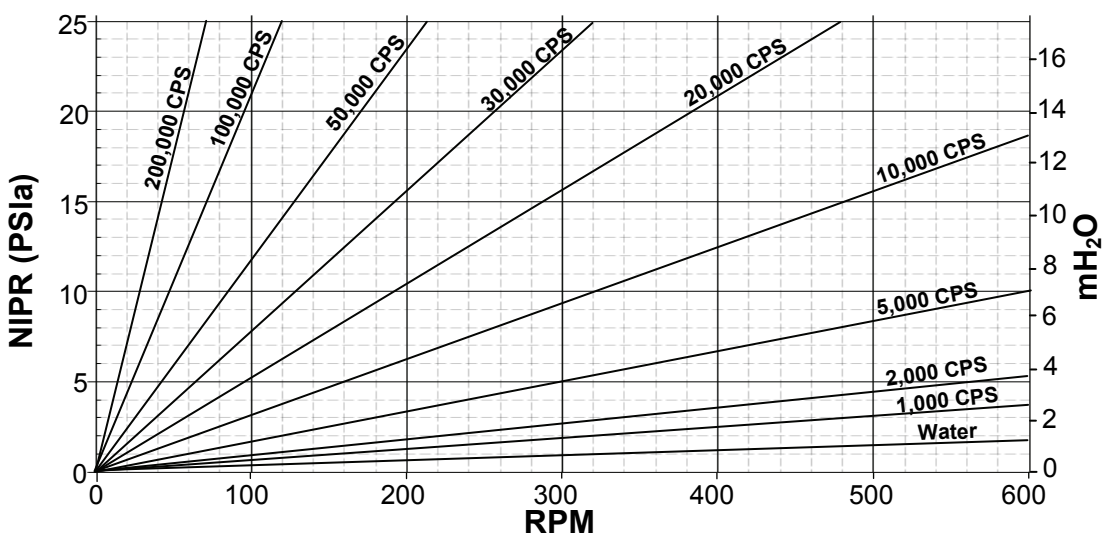

Ampco Pumps Company

2045 West Mill Road
 Glendale, WI 53209 USA
 Phone: (800) 737-8671
 (414) 643-1852

Website:
www.ampcopumps.com

ZP1 Series Positive Displacement Pumps

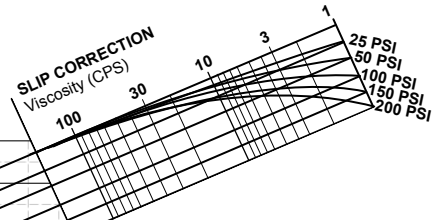
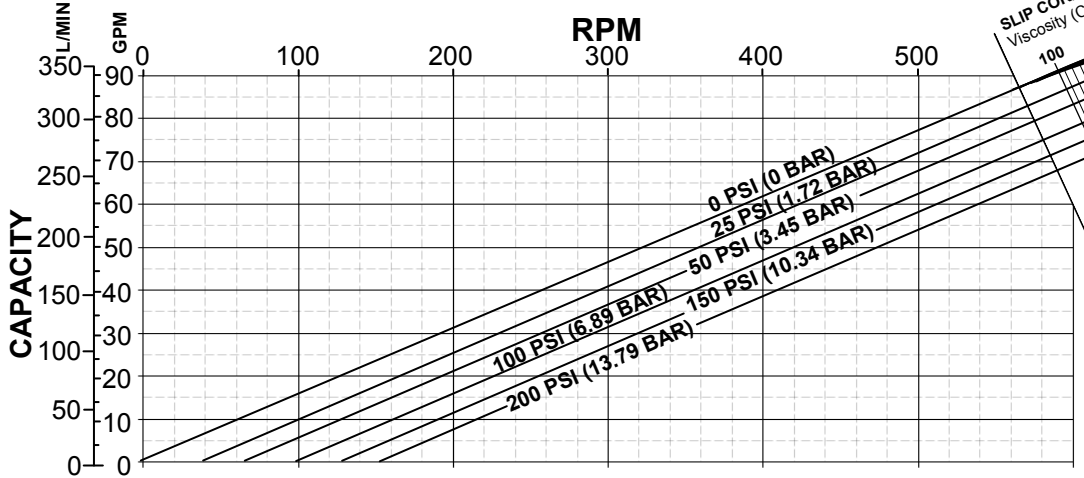

Ampco
ZP1 Series
Model: ZP1-60
ZP1-64

Standard Clearances
 Standard Port Size = 2.5"
 Displacement =
 0.153 Gal/Rev
 (0.579 L/Rev)



BHP = WHP + VHP

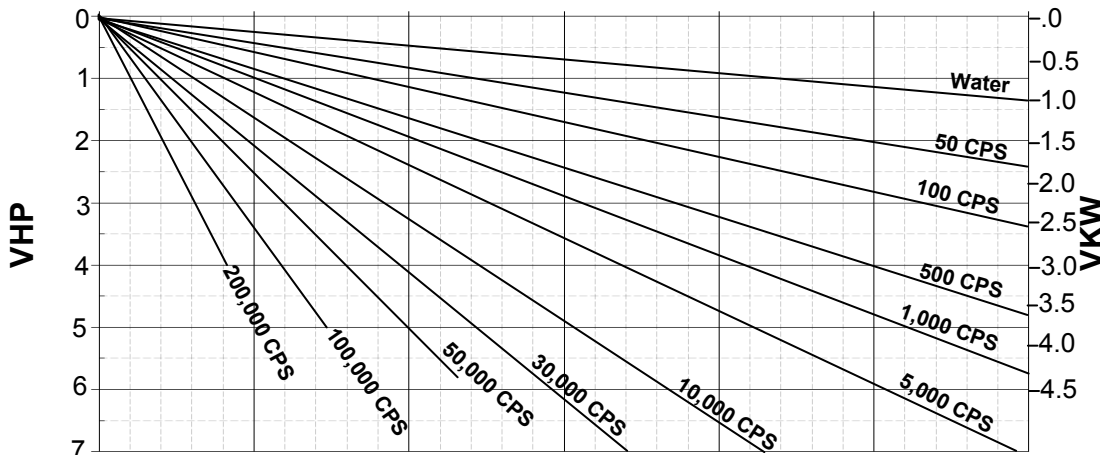

- Operating Specifications:
- 0-600 RPM Range
 - 200 PSI (13.8 bar) Max. Pressure
 - Temperature Range
 -40 °F (-40°C) to
 300 °F (149°C)

Subject to change without notice

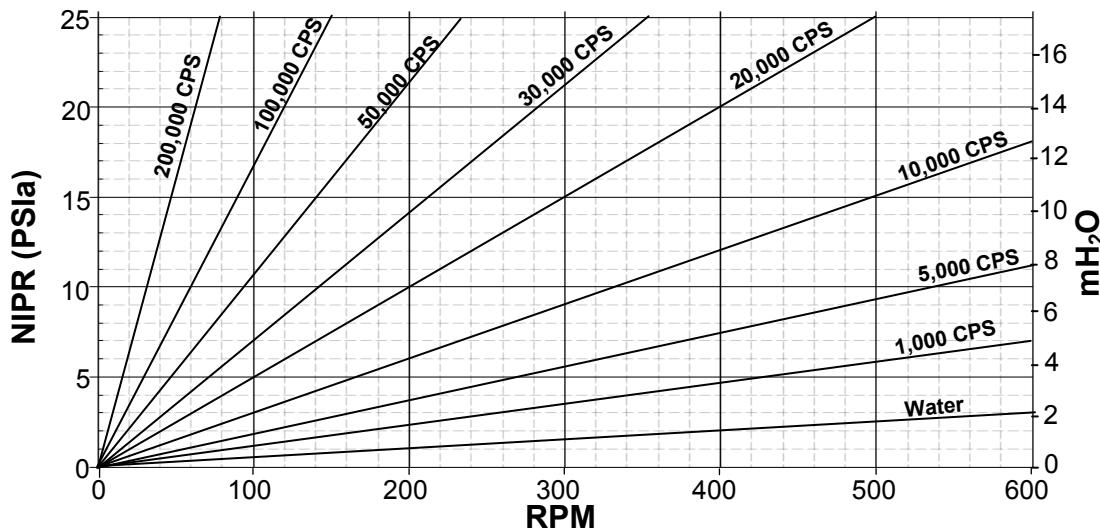

Ampco Pumps Company

2045 West Mill Road
 Glendale, WI 53209 USA
 Phone: (800) 737-8671
 (414) 643-1852

Website:
www.ampcopumps.com

ZP1 Series Positive Displacement Pumps

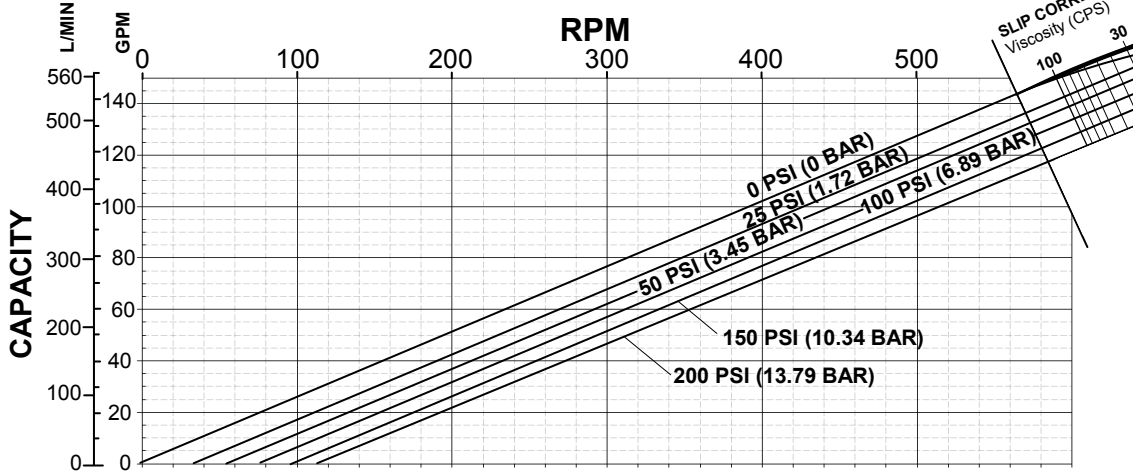

Ampco
ZP1 Series
Model: **ZP1-130**
ZP1-134

Standard Clearances
Standard Port Size = 3.0"
Displacement =
0.254 Gal/Rev
(0.961 L/Rev)

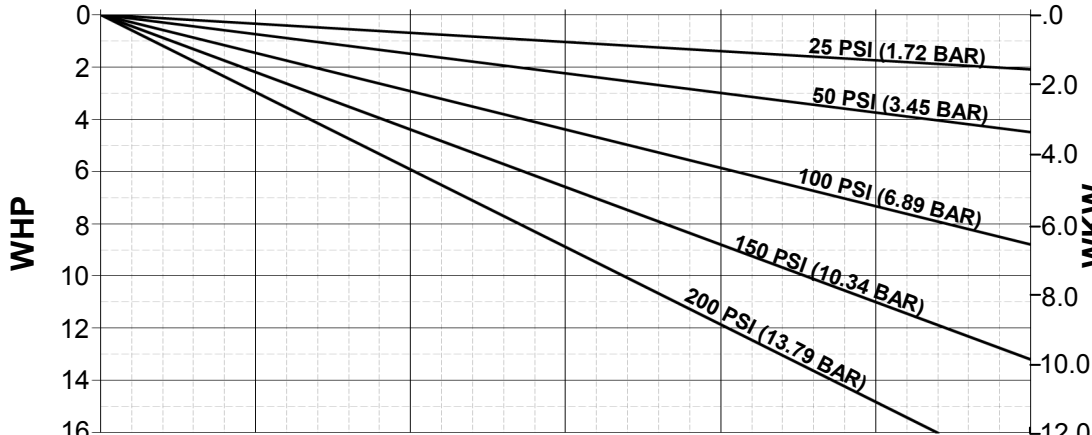

BHP = WHP + VHP

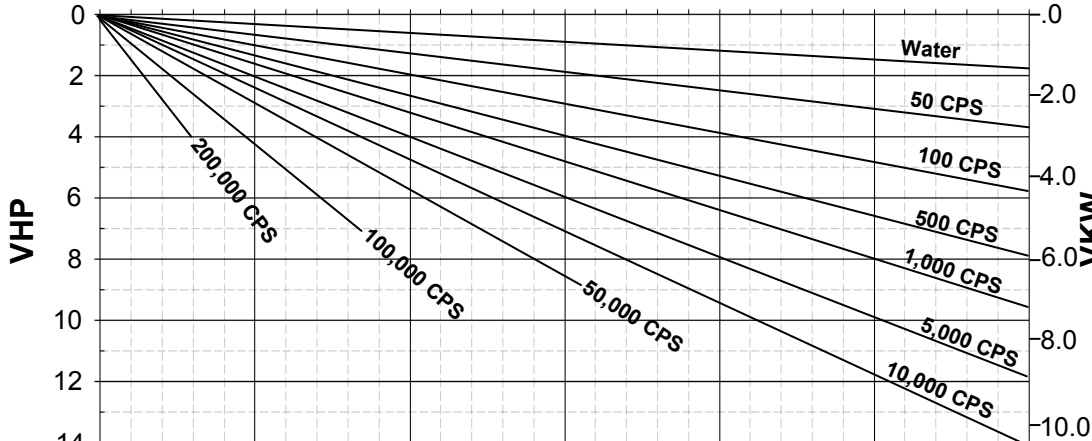

Operating Specifications:

- 0-600 RPM Range
- 200 PSI (13.8 bar) Max. Pressure
- Temperature Range
-40 °F (-40°C) to
300 °F (149°C)

Subject to change without notice

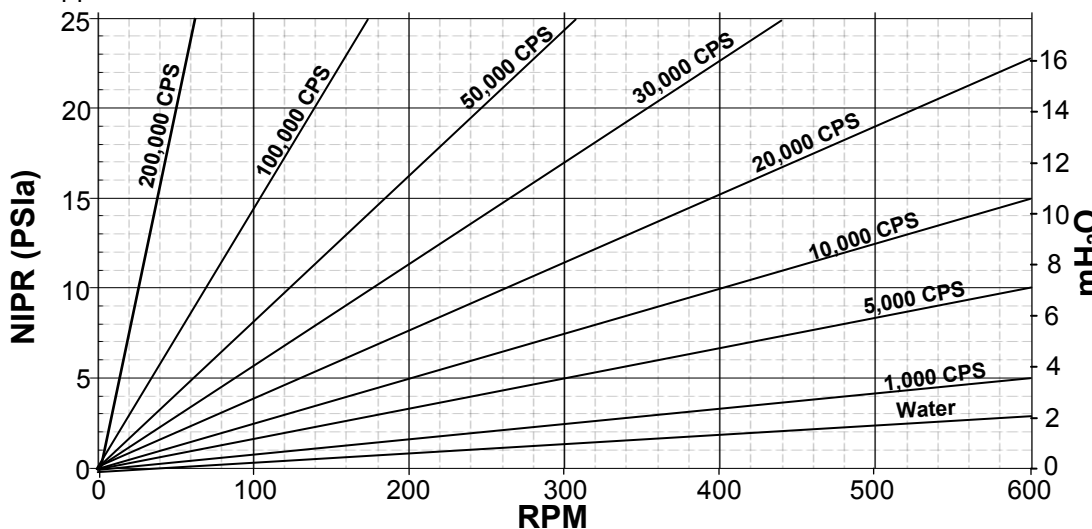

Ampco Pumps Company

2045 West Mill Road
Glendale, WI 53209 USA
Phone: (800) 737-8671
(414) 643-1852

Website:
www.ampcopumps.com

ZP1 Series Positive Displacement Pumps

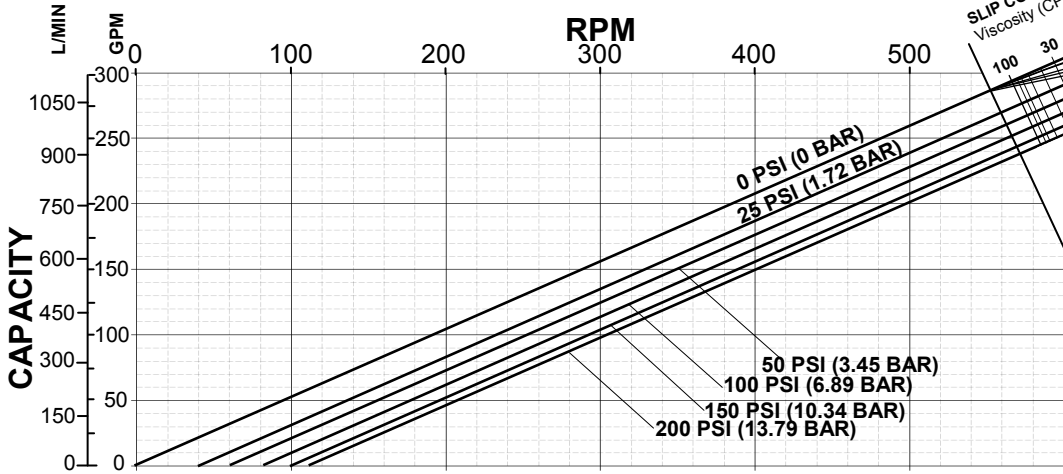

Ampco
ZP1 Series
Model: ZP1-220
ZP1-224

Standard Clearances
 Standard Port Size = 4.0"
 Displacement =
 0.522 Gal/Rev
 (1.976 L/Rev)

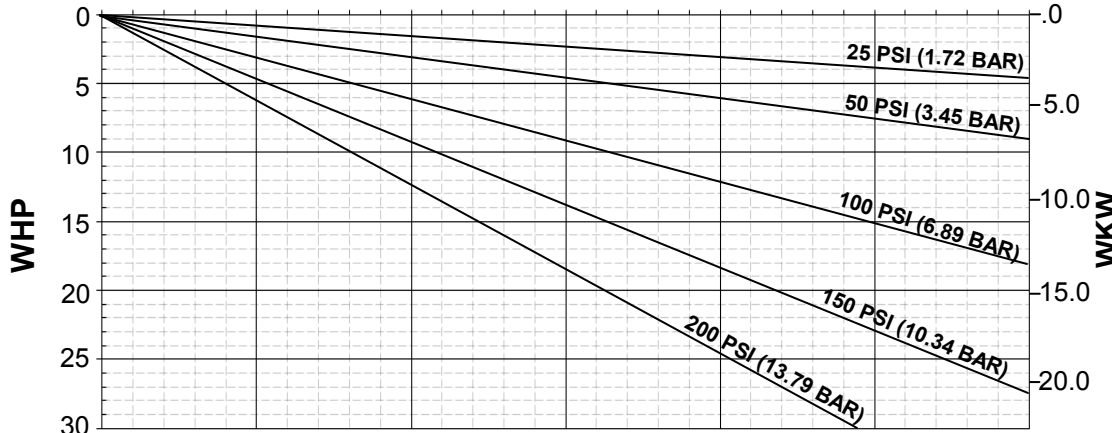

BHP = WHP + VHP

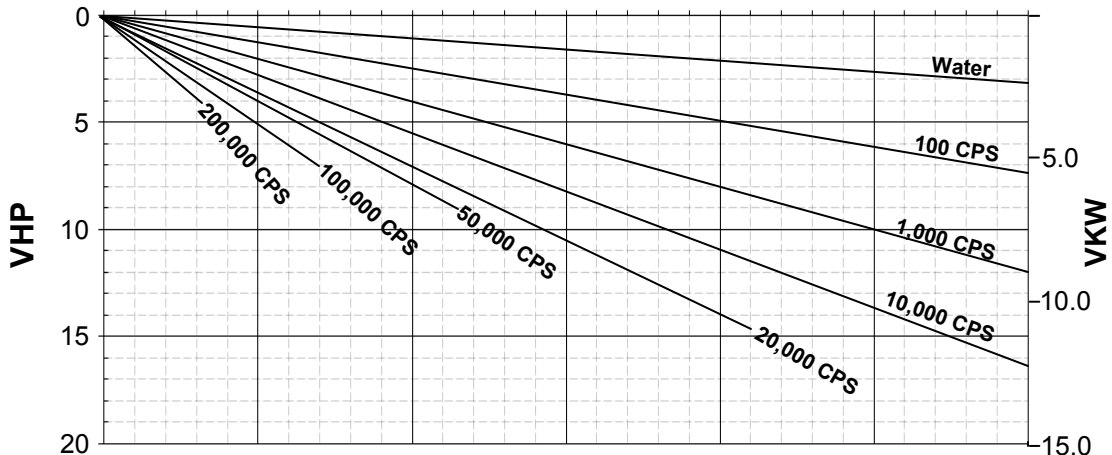

- Operating Specifications:
- 0-600 RPM Range
 - 200 PSI (13.8 bar) Max. Pressure
 - Temperature Range
 -40 °F (-40°C) to
 300 °F (149°C)

Subject to change without notice

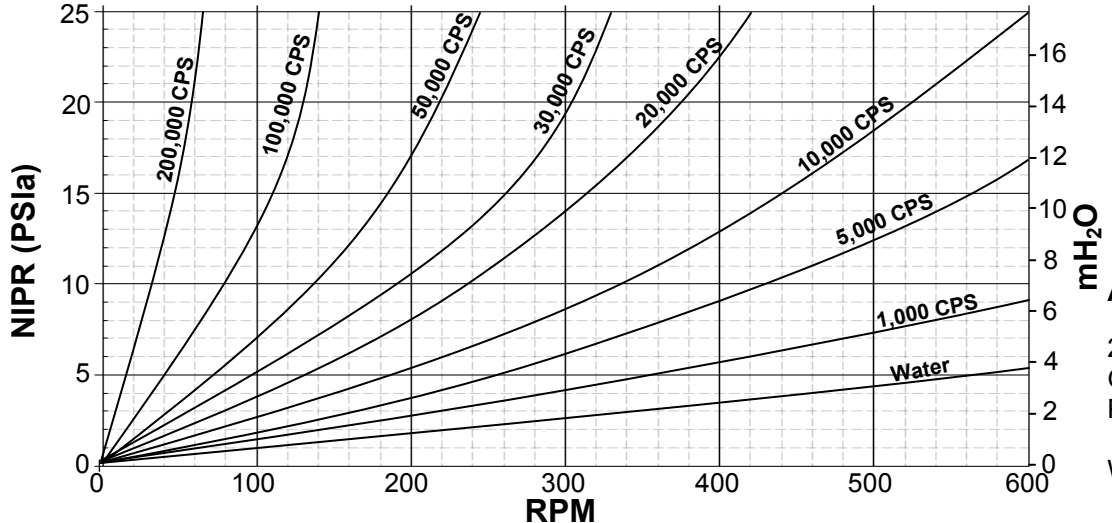

Ampco Pumps Company

2045 West Mill Road
 Glendale, WI 53209 USA
 Phone: (800) 737-8671
 (414) 643-1852

Website:
www.ampcopumps.com

ZP1 Series Positive Displacement Pumps

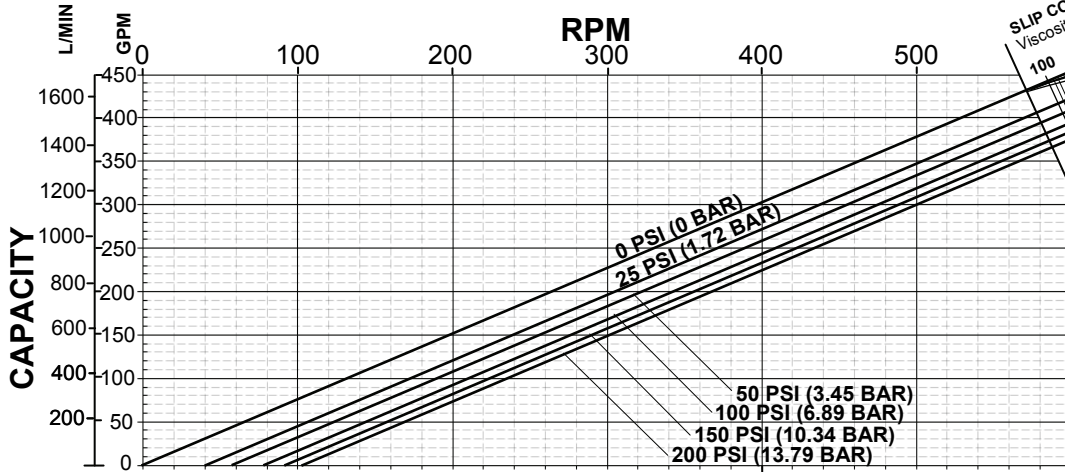

Ampco ZP1 Series Model: **ZP1-320**

Standard Clearances
Standard Port Size = 6.0"
Displacement =
0.754 Gal/Rev
(2.854 L/Rev)

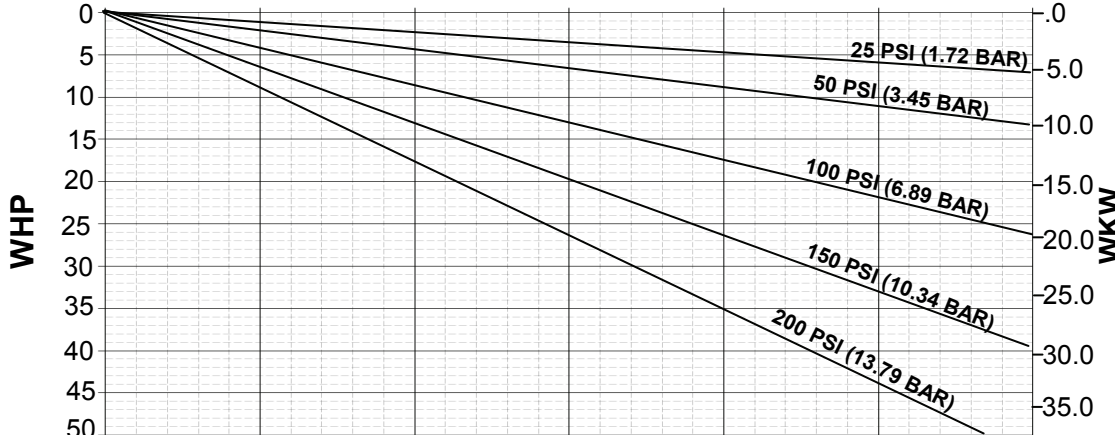

BHP = WHP + VHP

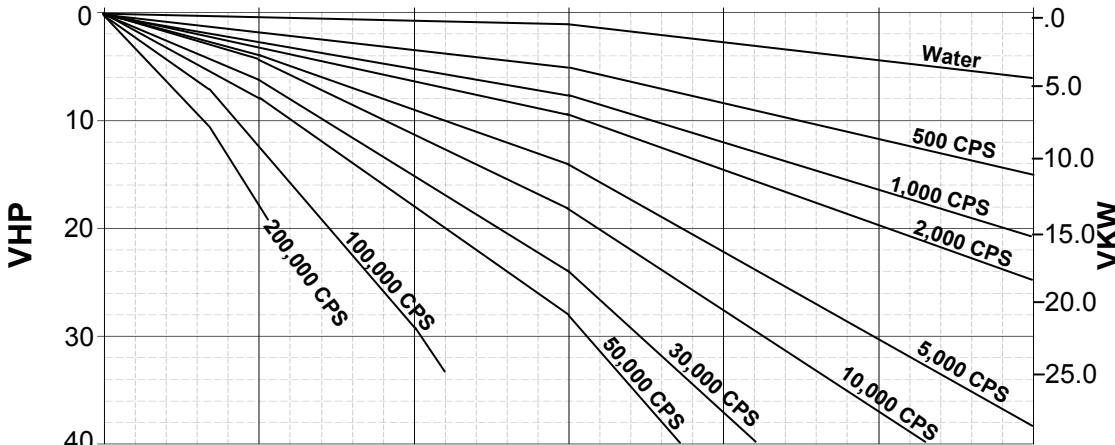

- Operating Specifications:
- 0-600 RPM Range
 - 200 PSI (13.8 bar) Max. Pressure
 - Temperature Range
-40 °F (-40°C) to
300 °F (149°C)

Subject to change without notice

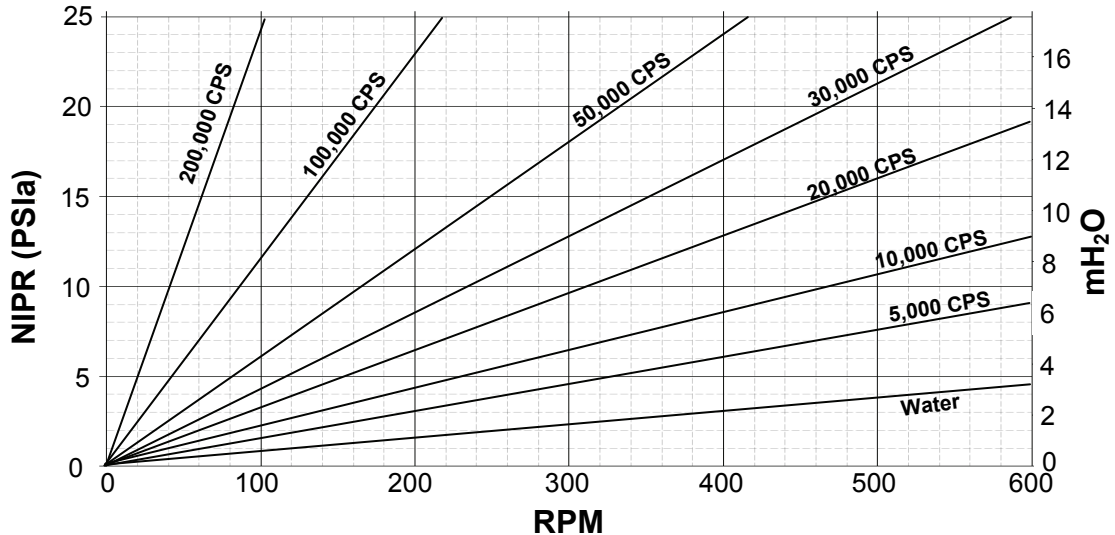

Ampco Pumps Company

2045 West Mill Road
Glendale, WI 53209 USA
Phone: (800) 737-8671
(414) 643-1852

Website:
www.ampcopumps.com